

Piastre di scorrimento *Wear plates*

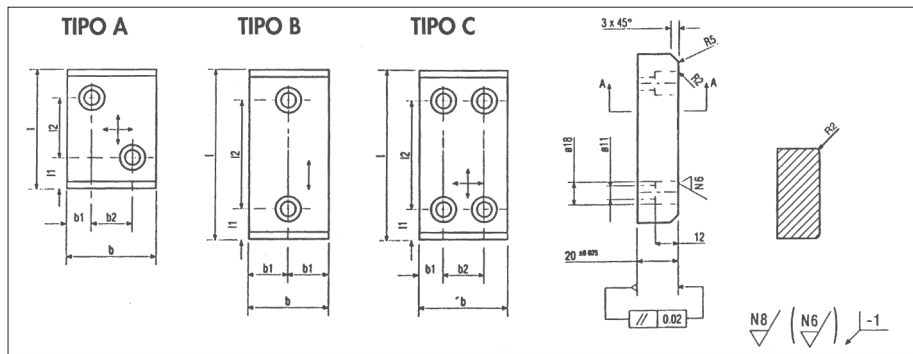

Codice	Materiale	Spessore S
Cod. A920	Acciaio trattato	20 ± 0,025
Cod. A980	Bronzo + grafite	20 ± 0,025

Codice	Materiale	Spessore S
Cod. A981	Acciaio trattato	20,5 ^{+0,3} / _{+0,5}

Tipo	b x l	b1	b2	l1	l2
B	28 x 75	14	-	15	45
B	28 x 100	14	-	25	50
B	28 x 150	14	-	25	100
B	38 x 75	19	-	15	45
B	38 x 100	19	-	25	50
B	38 x 150	19	-	25	100
B	48 x 75	24	-	15	45
B	48 x 100	24	-	25	50
B	48 x 125	24	-	25	75
B	48 x 150	24	-	25	100
B	58 x 75	29	-	15	45
B	58 x 100	29	-	25	50
B	58 x 150	29	-	25	100

*Per il codice A980 esiste solo la forma B.

Tipo	b x l	b1	b2	l1	l2
*A - B	75 x 75	25-(37,5)	25	25	25
*A - B	75 x 100	25-(37,5)	25	25	50
B	75 x 125	37,5	-	25	75
B	75 x 150	37,5	-	25	100
B	75 x 200	37,5	-	25	150
C	100 x 100	25	50	25	50
C	100 x 125	25	50	25	75
C	100 x 150	25	50	25	100
C	100 x 200	25	50	25	150
C	100 x 250	25	50	25	200
C	125 x 150	37,5	50	25	100
C	125 x 200	37,5	50	25	150
C	125 x 250	37,5	50	25	200
C	150 x 150	25	100	25	100
C	150 x 200	25	100	25	150
C	150 x 250	25	100	25	200

Esempio di ordinazione/Order example = A920/B58x100 (cod. + TIPO + bxl)