

AUTOMOTIVE

Normalizzati per stampi per automotive

Automotive standard parts for die















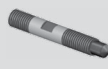









































AUTOMOTIVE

Standard parts

CF Torino - È vietata la riproduzione, anche parziale, del presente catalogo.

7.WA.1

Via Alba, 25 - 10024 Moncalieri (TO) - Italy
Tel. +39 011641121 - Fax +39 0116829188
cftorino@cftorino.it www.cftorino.it

<p>39D 506</p>  <p>Canotto guida Sleeve</p> <p>pag. 7.WA.4</p>	<p>39D 543</p>  <p>Bretella Brace</p> <p>pag. 7.WA.4</p>	<p>39D 549</p>  <p>Espulsori a molla Spring plunger</p> <p>pag. 7.WA.4</p>	<p>39D 571</p>  <p>Tirante Tie rod</p> <p>pag. 7.WA.4</p>	<p>39D 578</p>  <p>Reazione per cilindro Backing plate</p> <p>pag. 7.WA.4</p>	<p>39D 578</p>  <p>Reazione per cilindro Backing plate</p> <p>pag. 7.WA.5</p>	<p>39D 578</p>  <p>Distanziale Spacing bar</p> <p>pag. 7.WA.5</p>
<p>39D 578</p>  <p>Distanziale Spacing bar</p> <p>pag. 7.WA.5</p>	<p>39D 582</p>  <p>Guida angolare "L" shaped wear plates, self-lubricating</p> <p>pag. 7.WA.5</p>	<p>39D 592</p>  <p>Distanziale Spacer</p> <p>pag. 7.WA.5</p>	<p>39D 599</p>  <p>Tirante Tie rod</p> <p>pag. 7.WA.6</p>	<p>39D 599</p>  <p>Tirante Tie rod</p> <p>pag. 7.WA.6</p>	<p>39D 599</p>  <p>Tirante Tie rod</p> <p>pag. 7.WA.6</p>	<p>39D 630/22</p>  <p>Arresto slitta Slide stop block</p> <p>pag. 7.WA.6</p>
<p>39D 638</p>  <p>Candela Air pins</p> <p>pag. 7.WA.6</p>	<p>39D 638</p>  <p>Candela Air pins</p> <p>pag. 7.WA.7</p>	<p>39D 639</p>  <p>Supporto sensore Gage for Sensor</p> <p>pag. 7.WA.7</p>	<p>39D 639</p>  <p>Riferimento per sensore Gage with panel position sensor, hardened</p> <p>pag. 7.WA.7</p>	<p>39D 649</p>  <p>Spessore Shim</p> <p>pag. 7.WA.7</p>	<p>39D 650</p>  <p>Gruppo tirante Retainer bolt</p> <p>pag. 7.WA.8</p>	<p>39D 651</p>  <p>Ammortizzatore Elastomer spring</p> <p>pag. 7.WA.8</p>
<p>39D 807</p>  <p>Riferimento Gage</p> <p>pag. 7.WA.8</p>	<p>39D 807</p>  <p>Riferimento indurito Gage Hardened</p> <p>pag. 7.WA.8</p>	<p>39D 807</p>  <p>Riferimento indurito Gage Hardened</p> <p>pag. 7.WA.9</p>	<p>39D 807</p>  <p>Riferimento indurito Gage Hardened</p> <p>pag. 7.WA.9</p>	<p>39D 826</p>  <p>Chiavetta Key</p> <p>pag. 7.WA.9</p>	<p>39D 828</p>  <p>Gruppo distanziale Retainer bolt sets</p> <p>pag. 7.WA.9</p>	<p>39D 828</p>  <p>Rondella Washer</p> <p>pag. 7.WA.10</p>
<p>39D 828</p>  <p>Ammortizzatore Elastomer washer</p> <p>pag. 7.WA.10</p>	<p>39D 828</p>  <p>Gruppo distanziale Spacer group</p> <p>pag. 7.WA.10</p>	<p>39D 839</p>  <p>Staffa di sollevamento con perno VW-Audi Lifting bracket with pin VW-Audi</p> <p>pag. 7.WA.11</p>	<p>39D 847</p>  <p>Reazione per cilindro Pressure plate</p> <p>pag. 7.WA.11</p>	<p>39D 847</p>  <p>Reazione per cilindro Pressure plate</p> <p>pag. 7.WA.11</p>	<p>39D 851</p>  <p>Perno scorrevole Sliding pin</p> <p>pag. 7.WA.11</p>	<p>39D 851</p>  <p>Perno scorrevole Sliding pin</p> <p>pag. 7.WA.11</p>
<p>39D 854</p>  <p>Perno di arresto Pad retainer pin</p> <p>pag. 7.WA.12</p>	<p>39D 856</p>  <p>Piastrina Retainer plate</p> <p>pag. 7.WA.12</p>	<p>39D 860</p>  <p>Boccola autolubrificante DIN 9834 Guide bushes with collar, self-lubricating DIN 9834</p> <p>pag. 7.WA.12</p>	<p>39D 861</p>  <p>Ritegno per boccola Toe clamp</p> <p>pag. 7.WA.12</p>	<p>39D 861</p>  <p>Staffette per bussola Clamps for bushing</p> <p>pag. 7.WA.13</p>	<p>39D 862</p>  <p>Colonna guida DIN 9833 Guide post</p> <p>pag. 7.WA.13</p>	<p>39D 862</p>  <p>Colonna guida DIN 9833 Guide post</p> <p>pag. 7.WA.13</p>
<p>39D 863</p>  <p>Piastra guida autolubrificante VDI 3357 Wear plates, self-lubricating VDI 3357</p> <p>pag. 7.WA.14</p>	<p>39D 863</p>  <p>Piastra guida in acciaio VDI 3357 Wear plates, steel VDI 3357</p> <p>pag. 7.WA.14</p>	<p>39D 866</p>  <p>Perno di sollevamento Lifting pin</p> <p>pag. 7.WA.15</p>	<p>39D 866</p>  <p>Perno di sollevamento Lifting pin</p> <p>pag. 7.WA.15</p>	<p>39D 869</p>  <p>Rondella Washer</p> <p>pag. 7.WA.15</p>	<p>39D 870</p>  <p>Fissaggio cilindro Air cylinder fixing</p> <p>pag. 7.WA.15</p>	<p>39D 872</p>  <p>Supporto con rullo Cam roller</p> <p>pag. 7.WA.16</p>
<p>39D 873</p>  <p>Camma di accelerazione Acceleration cam</p> <p>pag. 7.WA.16</p>	<p>39D 876</p>  <p>Staffa di sollevamento VDI 3366 Lifting brackets VDI 3366</p> <p>pag. 7.WA.16</p>	<p>39D 882</p>  <p>Fissaggio cilindro Air cylinder fixing</p> <p>pag. 7.WA.16</p>	<p>39D 882</p>  <p>Fissaggio cilindro Air cylinder fixing</p> <p>pag. 7.WA.17</p>	<p>39D 887</p>  <p>Adattatore per cilindro Air cylinder adapter</p> <p>pag. 7.WA.17</p>	<p>39D 887</p>  <p>Adattatore per cilindro Air cylinder adapter</p> <p>pag. 7.WA.17</p>	<p>39D 890</p>  <p>Piastra guida autolubrificante Wear plates, self-lubricating</p> <p>pag. 7.WA.17</p>

<p>39D 892</p> <p>Lardone autolubrificante VDI 3357 Wear strip with two slide surfaces VDI 3357</p> <p>pag. 7.WA.18</p>	<p>39D 894</p> <p>Cuneo autolubrificante VDI 3357 Cam dwell wear plate, self-lubricating</p> <p>pag. 7.WA.18</p>	<p>39D 894</p> <p>Cuneo in acciaio VDI 3357 Cam dwell wear plate, steel</p> <p>pag. 7.WA.18</p>	<p>39D 895</p> <p>Chiavetta Key</p> <p>pag. 7.WA.18</p>	<p>39D 896</p> <p>Gruppo perno di compensazione Compensation pin group</p> <p>pag. 7.WA.19</p>	<p>39D 896</p> <p>Gruppo perno di compensazione Compensation pin group</p> <p>pag. 7.WA.19</p>	<p>39D 896</p> <p>Gruppo perno di compensazione Compensation pin group</p> <p>pag. 7.WA.19</p>
<p>39D 896</p> <p>Gruppo perno di compensazione Compensation pin group</p> <p>pag. 7.WA.19</p>	<p>39D 896</p> <p>Reazione per cilindro Pressure plate</p> <p>pag. 7.WA.19</p>	<p>39D 896</p> <p>Piastrina Retainer</p> <p>pag. 7.WA.20</p>	<p>39D 896</p> <p>Piastrina Retainer</p> <p>pag. 7.WA.20</p>	<p>39D 896</p> <p>Piastrina Retainer</p> <p>pag. 7.WA.20</p>	<p>39D 951</p> <p>Candela Air pin</p> <p>pag. 7.WA.20</p>	<p>39D 951/21</p> <p>Candela Air pin</p> <p>pag. 7.WA.20</p>
<p>39D 952</p> <p>Guida a "V" in acciaio VDI 3357 "V" driver, steel VDI 3357</p> <p>pag. 7.WA.21</p>	<p>39D 952</p> <p>Guida a "V" autolubrificante VDI 3357 "V" driver, self-lubricating VDI 3357</p> <p>pag. 7.WA.21</p>	<p>39D 954</p> <p>Piastra guida autolubrificante VDI 3357 Wear plates, self-lubricating VDI 3357</p> <p>pag. 7.WA.21</p>	<p>39D 954</p> <p>Piastra guida in acciaio VDI 3357 Wear plates, steel VDI 3357</p> <p>pag. 7.WA.22</p>	<p>39D 956</p> <p>Boccola autolubrificante Guide bushes, self-lubricating</p> <p>pag. 7.WA.22</p>	<p>39D 958</p> <p>Perno di arresto Stop pin</p> <p>pag. 7.WA.22</p>	<p>39D 969</p> <p>Colonna guida tipo DIN 9833 Guide posts DIN 9833</p> <p>pag. 7.WA.22</p>
<p>39D 972</p> <p>Sollevatore Lifter</p> <p>pag. 7.WA.23</p>	<p>39D 976</p> <p>Tassello di compensazione Spacer plates, toothed with adjusting plate</p> <p>pag. 7.WA.23</p>	<p>39D 993</p> <p>Piastrina portasensore Plate for sensor</p> <p>pag. 7.WA.23</p>	<p>39D 995</p> <p>Distanziale Spacer</p> <p>pag. 7.WA.23</p>	<p>39D 995</p> <p>Rondella Washer</p> <p>pag. 7.WA.23</p>	<p>39D 995 / 6 / 7</p> <p>Tassello Stop block</p> <p>pag. 7.WA.24</p>	<p>39D 995</p> <p>Perno con rondella Retainer bolt sets</p> <p>pag. 7.WA.24</p>
<p>39D 1392</p> <p>Distributore Distributor</p> <p>pag. 7.WA.24</p>	<p>39D 996</p> <p>Guida a "V" con piastrine di scorrimento intercambiabili e ritorno di sicurezza "V" driver sets with replaceable inserts with positive return</p> <p>pag. 7.WA.24</p>	<p>39D 1430</p> <p>Distributore Distributor</p> <p>pag. 7.WA.25</p>	<p>39V 863</p> <p>Punzone di visualizzazione Visual locator setting punch</p> <p>pag. 7.WA.25</p>	<p>39V 1071</p> <p>Boccola filettata Threaded bush</p> <p>pag. 7.WA.25</p>	<p>39V 1159</p> <p>Blocco guida autolubrificante in acciaio Removable die heels, steel and self-lubricating</p> <p>pag. 7.WA.25</p>	<p>39V 1162</p> <p>Distanziale Stop block</p> <p>pag. 7.WA.26</p>
<p>39V 1162</p> <p>Distanziale Stop block</p> <p>pag. 7.WA.26</p>	<p>39V 1168</p> <p>Cono di centraggio Locating cone</p> <p>pag. 7.WA.26</p>	<p>39V 1199</p> <p>Perno di sollevamento VDI 3366 Lifting pins VDI 3366</p> <p>pag. 7.WA.26</p>	<p>39V 1205</p> <p>Centraggio Locating pins</p> <p>pag. 7.WA.27</p>	<p>39V 1242</p> <p>Riferimento Gage</p> <p>pag. 7.WA.27</p>	<p>39V 1254</p> <p>Tassello di centraggio Locating block</p> <p>pag. 7.WA.27</p>	<p>39V 1304</p> <p>Chiavetta Key</p> <p>pag. 7.WA.27</p>
<p>39V 1304</p> <p>Chiavetta Key</p> <p>pag. 7.WA.28</p>	<p>39V 1569</p> <p>Rullino sollevamento nastro Roller stock lifter</p> <p>pag. 7.WA.28-29</p>					

Canotto guida *Sleeve*

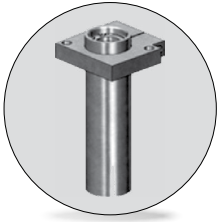

Codice/Code	Materiale/Material
Cod. 39D 506	Acciaio/Steel

VW code
39D 506/10

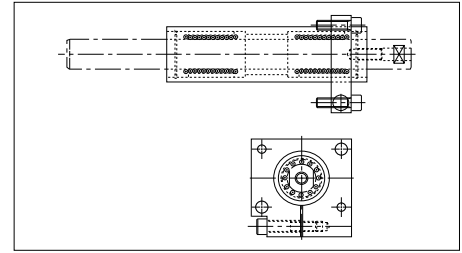

Esempio di ordinazione/Order example = 39D 506/10 (VW code)

Bretella *Brace*

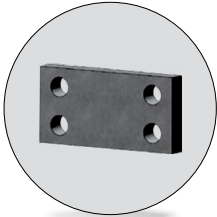

Codice/Code	Materiale/Material
Cod. 39D 543	CK45

VW code	b	l
39D 543/1	80	???
39D 543/2	100	???

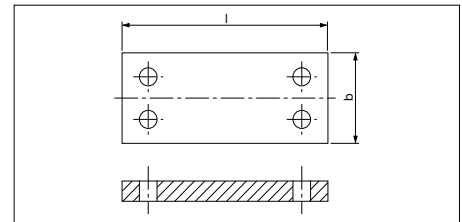

Esempio di ordinazione/Order example = 39D 543/1+l (VW code+l)

I da indicare in fase di ordinazione.
I indicate when ordering.

Espulsore a molla *Spring plunger*



Codice/Code	Materiale/Material
Cod. 39D 549	Acciaio/Steel

VW code	d1	L1	L2	VW code	d1	L1	L2
39D 549/10	M10			39D 549/27	M16x1,5	80	30
39D 549/26	M16x1,5	80	20	39D 549/28		150	50

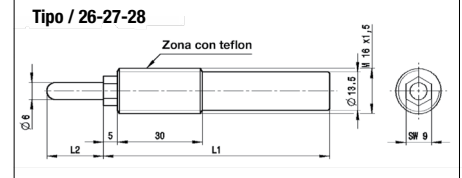
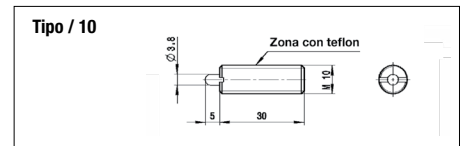

Esempio di ordinazione/Order example = 39D 549/10 (VW code)

INDEX

Tirante *Tie rod*



Codice/Code	Materiale/Material
Cod. 39D 571	Acciaio/Steel

VW code	d1	VW code	d1
39D 571/10	10	39D 571/16	16
39D 571/13	13	39D 571/20	20

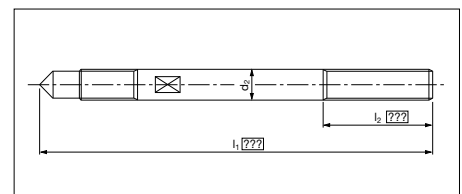

Esempio di ordinazione/Order example = 39D 571/10+l1+l2 (VW code+l1+l2)

l1 e l2 da indicare in fase di ordinazione.
l1 and l2 indicate when ordering.

AUTOMOTIVE

Reazione per cilindro *Backing plate*

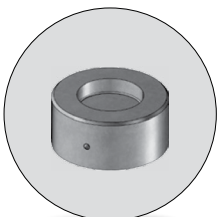

Codice/Code	Materiale/Material
Cod. 39D 578	CK45

VW code	d1
39D 578/55	90
39D 578/56	100

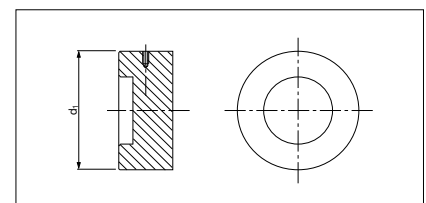

Esempio di ordinazione/Order example = 39D 578/55 (VW code)

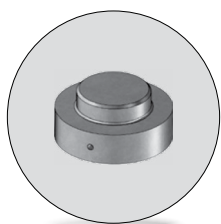

Reazione per cilindro *Backing plate*

Codice/Code	Materiale/Material
Cod. 39D 578	CK45
VW code	
39D 578/65	

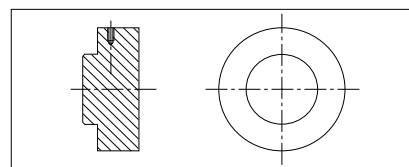

Esempio di ordinazione/Order example = 39D 578/65 (VW code)

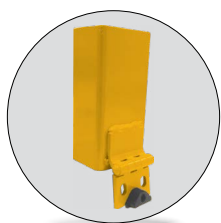

Distanziale *Spacing bar*

Codice/Code	Materiale/Material		
Cod. 39D 578	St 37		
VW code			
	a1	a2	s
39D 578/30	100	60	7-8
39D 578/40	70	50	3

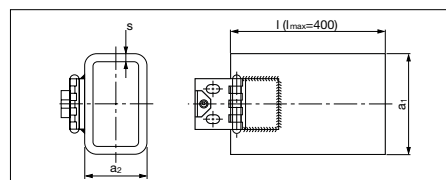

I da indicare in fase di ordinazione.
I indicate when ordering.

Esempio di ordinazione/Order example = 39D 578/30+I (VW code+I)

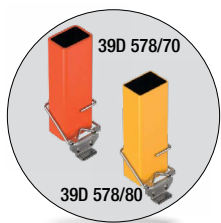

Distanziale *Spacing bar*

Codice/Code	Cod. 39D 578			
Materiale/Material	1 - S235JR	2 - 1.4310		
	3 e 4 - S235/DC01	5 - Soft-PVC		
	6 - M6 DIN 934	7 - Rivetto Ø5x14 DIN 7337		
VW code				
	a	b	l	t
39D 578/70	70	50	???	5
39D 578/80	70	50	???	3

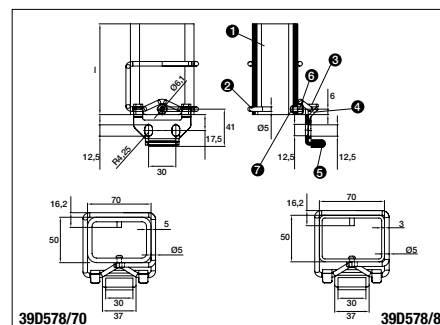

Esempio di ordinazione/Order example = 39D 578/70+I (VW code+I)

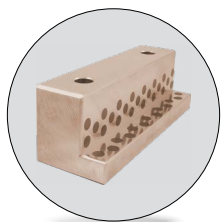

Guida angolare "L" shaped wear plates, self-lubricating

Codice/Code	Materiale/Material
Cod. 39D 582	Bronzo + grafite HB ≥ 190

VW code	Forma	b1	h1	l1	VW code	Forma	b1	h1	l1
39D 582/1	A	25	15,5	125	39D 582/12	A	70	75,5	200
39D 582/2	A	25	15,5	160	39D 582/13	B	70	75,5	250
39D 582/3	A	32	30,5	125	39D 582/15	C	70	75,5	400
39D 582/4	A	32	30,5	160	39D 582/16	A	85	90,5	160
39D 582/5	A	32	30,5	200	39D 582/17	A	85	90,5	200
39D 582/6	A	55	55,5	100	39D 582/18	B	85	90,5	250
39D 582/7	A	55	55,5	160	39D 582/20	C	85	90,5	400
39D 582/11	A	70	75,5	160					

Esempio di ordinazione/Order example = 39D 582/1 (VW code)

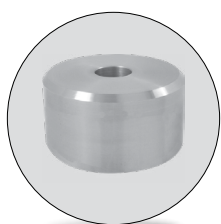
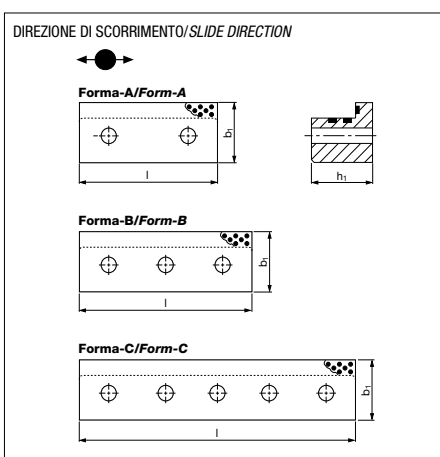

Distanziale *Spacer*

Codice/Code	Materiale/Material				
Cod. 39D 592	CK45				
VW code					
	d1	h1	VW code	d1	h1
39D 592/10	25	??	39D 592/12	40	??
39D 592/11	30	??	39D 592/13	50	??

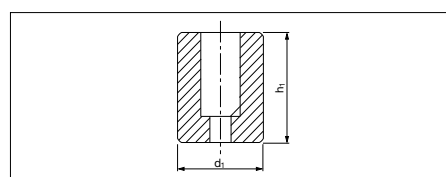

h1 da indicare in fase di ordinazione.
h1 indicate when ordering.

Esempio di ordinazione/Order example = 39D 592/10+h1 (VW code+h1)

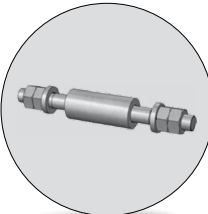

Tirante *Tie rod*

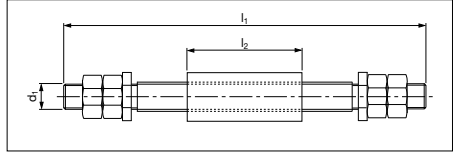

Codice/Code	Materiale/Material		
Cod. 39D 599	34Cr4		

VW code	d1	l1	l2
39D 599/1	M42x1,5	???	???

Esempio di ordinazione/Order example = 39D 599/1+l1+l2 (VW code+l1+l2)

l1 e l2 da indicare in fase di ordinazione.
l1 and l2 indicate when ordering.

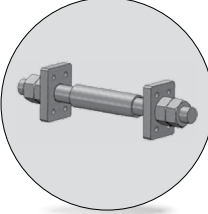

Tirante *Tie rod*

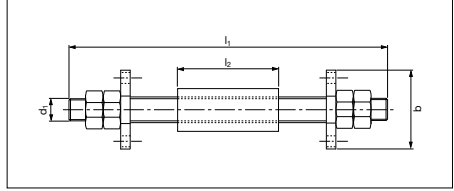

Codice/Code	Materiale/Material		
Cod. 39D 599	34Cr4		

VW code	b	d1	l1	l2
39D 599/2	140	M42x1,5	???	???
39D 599/5	160	M42x1,5	???	???

Esempio di ordinazione/Order example = 39D 599/2+l1+l2 (VW code+l1+l2)

l1 e l2 da indicare in fase di ordinazione.
l1 and l2 indicate when ordering.

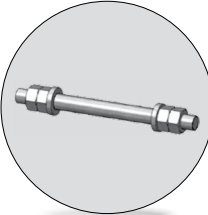

Tirante *Tie rod*

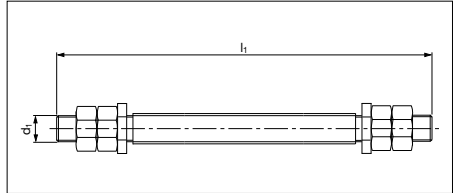

Codice/Code	Materiale/Material	
Cod. 39D 599	34Cr4	

VW code	d1	l1
39D 599/3	M42x1,5	???
39D 599/4	M56x1,5	???

Esempio di ordinazione/Order example = 39D 599/3+l1 (VW code+l1)

l1 da indicare in fase di ordinazione.
l1 indicate when ordering.

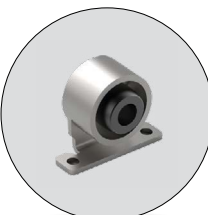

Arresto slitta *Slide stop block*

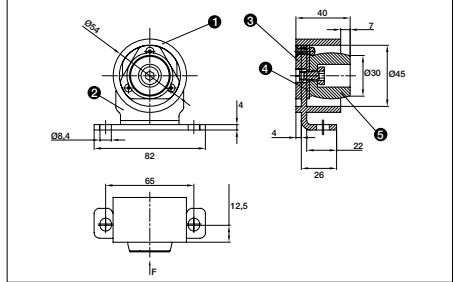

Codice/Code	Materiale/Material	
Cod. 39D 630/22	1 - 2 - 3 - S355	
	4 - S355/DC01	
	5 - Co-Polyester elastomer	

VW code
39D 630/22

Esempio di ordinazione/Order example = 39D 630/22 (VW code)



Candela *Air pins*

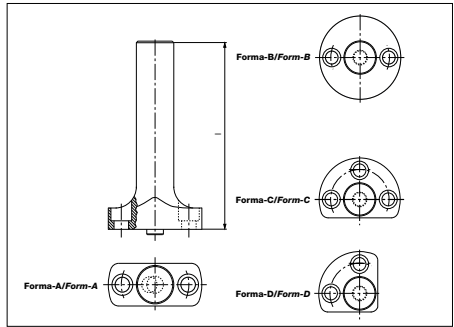

Codice/Code	Materiale/Material	
Cod. 39D 638	CK45	
	800 ÷ 1000 N/mm ²	

VW code	Forma Form	l	Carico max Max load kN
39D 638/2	A	???	50
39D 638/3	B	???	50
39D 638/4	C	???	50
39D 638/5	D	???	50

Esempio di ordinazione/Order example = 39D 638/2+l (VW code+l)

l da indicare in fase di ordinazione.
Lunghezza massima = 360 mm.
l indicate when ordering.
l Max= 360 mm.

ONLY FOR REPLACEMENT

Candela *Air pins*

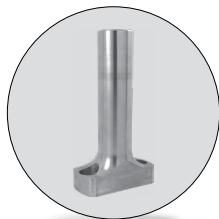

Codice/Code	Materiale/Material
Cod. 39D 638	42CrMo4 800 ÷ 1000 N/mm ²

VW code	Forma	l	Carico max Max load kN
39D 638/10	A	???	50
39D 638/11	B	???	50
39D 638/12	C	???	50

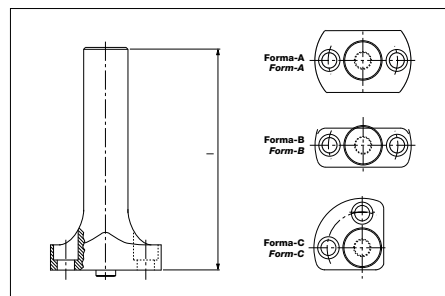

Esempio di ordinazione/Order example = 39D 638/10+l (VW code+l)

l da indicare in fase di ordinazione. *l* indicate when ordering.
Lunghezza massima = 360 mm. *l* Max= 360 mm.

Riferimento per sensore *Gage with panel position sensor, hardened*



Codice/Code	Materiale/Material
Cod. 39D 639	CK60 HRC 50 ÷ 55 Piastrina: acciaio/Retainer: steel HRC 58 ÷ 60

VW code	l	VW code	l
39D 639/20	120	39D 639/22	180
39D 639/21	150	39D 639/23	250

Esempio di ordinazione/Order example = 39D 639/20 (VW code)

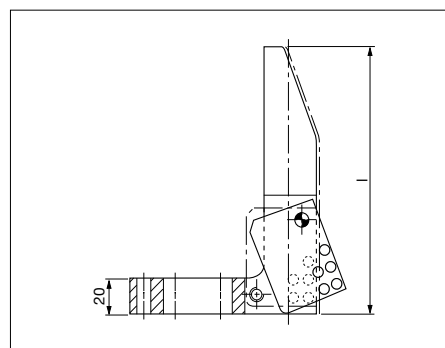

Supporto sensore *Gage for Sensor*

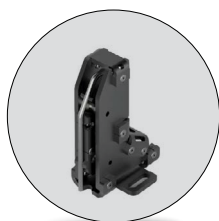

Codice/Code	Cod. 39D 639	
Materiale Material	1 - S635	2 - 1.4021 Indurito/hardened HRC 40-45
	3 - Molla/Spring DIN 2098	4 - M6 DIN 934
	5 - Vite/Screw M6x12 ISO 4762	6 - Rivetto/Rivet Ø4x14 DIN 733

VW code	l1	l
39D 639/40	87	145
39D 639/41	127	185
39D 639/42	167	225

Esempio di ordinazione/Order example = 39D 639/40 (VW code)

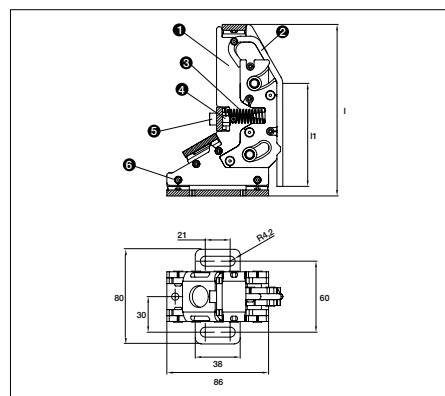

Spessore *Shim*

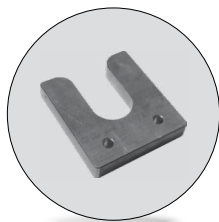

Codice/Code	Materiale/Material
Cod. 39D 649	Acciaio/Steel

VW code	l1
39D 649/1	110
39D 649/2	135
39D 649/3	185
39D 649/4	160

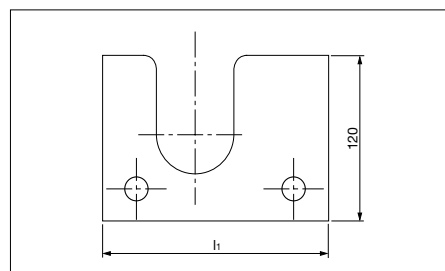

Esempio di ordinazione/Order example = 39D 649/1 (VW code)

INDEX

AUTOMOTIVE

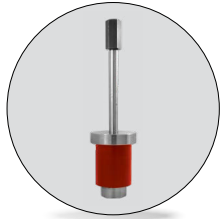

Gruppo tirante *Retainer bolt*

Codice/Code	Materiale/Material
Cod. 39D 650	Acciaio elastomero <i>Steel elastomer</i>

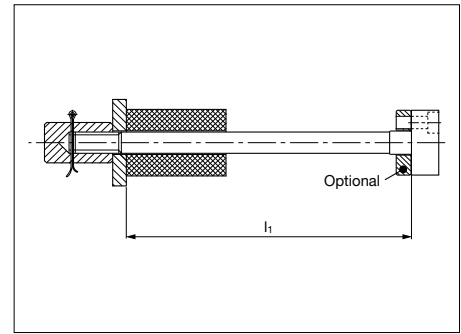

VW code	Carico max Max load (N)	Elastomero Elastomer (nero) Sh	VW code	Carico max Max load (N)	Elastomero Elastomer (rosso) Sh
39D 650/51	15000	68	39D 650/55	15000	90
39D 650/52	25000	68	39D 650/56	25000	90
39D 650/53	25000	68	39D 650/57	25000	90
39D 650/54	45000	68	39D 650/38	45000	90

l1 da indicare in fase di ordinazione.
l1 indicate when ordering.
Rispettare il carico max. *Respect the max load.*

Esempio di ordinazione/Order example = 39D 650/51+l1 (VW code+l1)

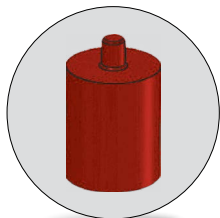

Ammortizzatore *Elastomer spring*

Codice/Code	Materiale/Material
Cod. 39D 651	Elastomero/ <i>Elastomer 92 SH</i>

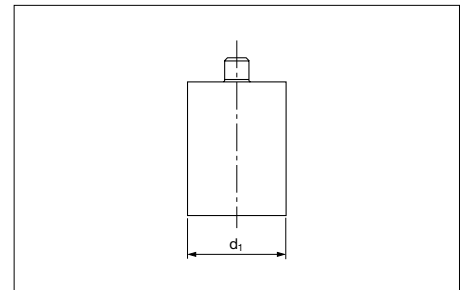

VW code	d1
39D 651/1	63
39D 651/2	80
39D 651/3	100
39D 651/4	125

Esempio di ordinazione/Order example = 39D 651/1 (VW code)

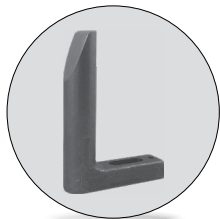

Riferimento *Gage*

Codice/Code	Materiale/Material
Cod. 39D 807	CK60

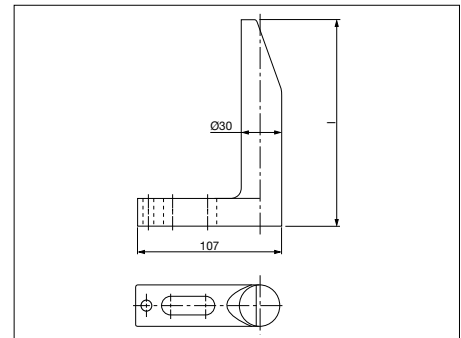

VW code	l	VW code	l
39D 807/1 L=65	65	39D 807/1 L=180	180
39D 807/1 L=90	90	39D 807/1 L=250	250
39D 807/1 L=120	120	39D 807/1 L=300	300
39D 807/1 L=150	150	39D 807/1 L=350	350

Esempio di ordinazione/Order example = 39D 807/1 L=65 (VW code)

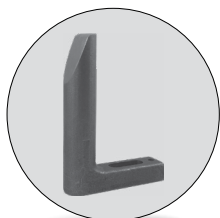

Riferimento indurito *Gage hardened*

Codice/Code	Materiale/Material
Cod. 39D 807	CK60 HRC 58 ÷ 60

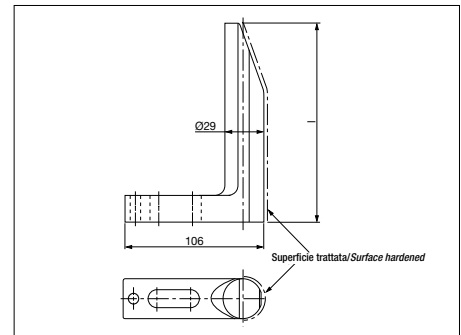

VW code	l	VW code	l
39D 807/2 L=65	65	39D 807/2 L=180	180
39D 807/2 L=90	90	39D 807/2 L=250	250
39D 807/2 L=120	120	39D 807/2 L=300	300
39D 807/2 L=150	150	39D 807/2 L=350	350

Esempio di ordinazione/Order example = 39D 807/2 L=65 (VW code)

Riferimento indurito *Gage hardened*

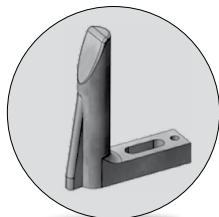

Codice/Code	Materiale/Material
Cod. 39D 807	CK60 90MnCrV8 HRC 54 ÷ 58

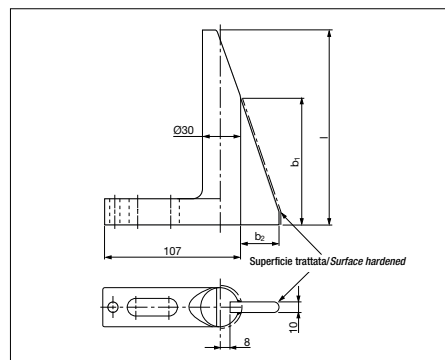

VW code	l	VW code	l
39D 807/3 L=65	65	39D 807/3 L=180	180
39D 807/3 L=90	90	39D 807/3 L=250	250
39D 807/3 L=120	120	39D 807/3 L=300	300
39D 807/3 L=150	150	39D 807/3 L=350	350

Esempio di ordinazione/Order example = 39D 807/3 L=65+b1+b2 (VW code+b1+b2)

b1 e b2 da indicare in fase di ordinazione.
b1 and b2 indicate when ordering.

Riferimento indurito *Gage hardened*

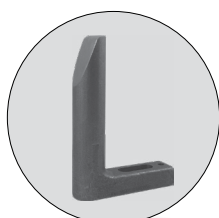

Codice/Code	Materiale/Material
Cod. 39D 807	CK60 HRC 58 ÷ 60

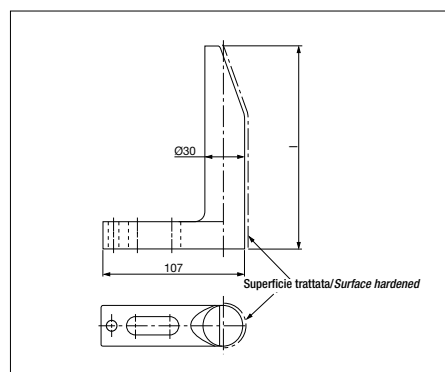

VW code	l	VW code	l
39D 807/4 L=65	65	39D 807/4 L=180	180
39D 807/4 L=90	90	39D 807/4 L=250	250
39D 807/4 L=120	120	39D 807/4 L=300	300
39D 807/4 L=150	150	39D 807/4 L=350	350

Esempio di ordinazione/Order example = 39D 807/4 L=65 (VW code)

Chiavetta *Key*

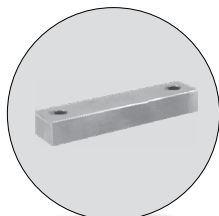

Codice/Code	Materiale/Material
Cod. 39D 826	16MnCr5; HRC 58 ÷ 60
VW code	
39D 826	

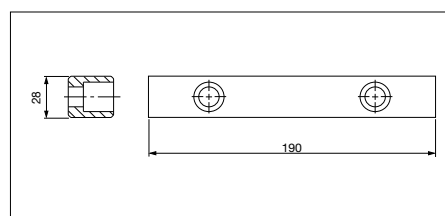

Esempio di ordinazione/Order example = 39D 826 (VW code)

Gruppo distanziale *Retainer bolt sets*

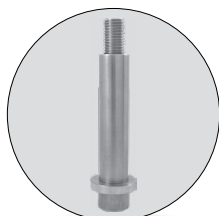

Codice/Code	Materiale/Material
Cod. 39D 828	Tube: Acciaio/Steel Rondella: CK45

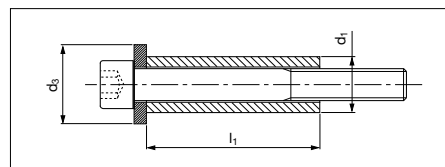

VW code	d1 x l1	d3	VW code	d1 x l1	d3	VW code	d1 x l1	d3
39D 828/4	16 x 40	25	39D 828/12	20 x 100	30	39D 828/20	36 x 80	55
39D 828/5	16 x 50	25	39D 828/13	25 x 63	38	39D 828/21	36 x 100	55
39D 828/6	16 x 63	25	39D 828/14	25 x 80	38	39D 828/22	36 x 125	55
39D 828/8	16 x 100	25	39D 828/15	25 x 100	38	39D 828/23	42 x 80	65
39D 828/9	20 x 50	30	39D 828/16	25 x 125	38	39D 828/24	42 x 100	65
39D 828/10	20 x 63	30	39D 828/17	30 x 80	45	39D 828/25	42 x 125	65
39D 828/11	20 x 80	30	39D 828/19	30 x 125	45			

Esempio di ordinazione/Order example = 39D 828/4 (VW code)



Rondella Washer

Codice/Code	Materiale/Material
Cod. 39D 828	CK45

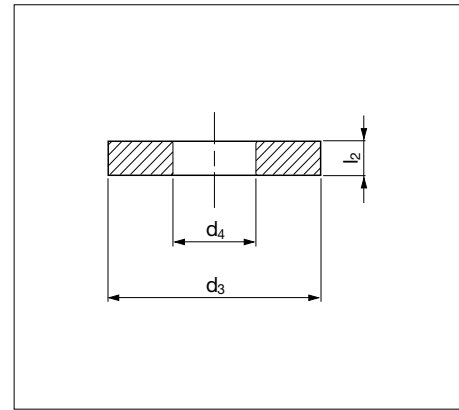

VW code	d3	d4	l2	VW code	d3	d4	l2
39D 828/41	25	10,5	5	39D 828/47	35	13,0	5
39D 828/42	30	13,2	5	39D 828/48	50	17,0	6
39D 828/43	38	17,0	6	39D 828/49	65	21,0	8
39D 828/44	45	21,0	8	39D 828/50	70	25,0	10
39D 828/45	55	25,0	10	39D 828/57	65	32,0	15
39D 828/46	30	10,5	5	39D 828/58	90	32,0	15

Esempio di ordinazione/Order example = 39D 828/41 (VW code)



Ammortizzatore Elastomer washer

Codice/Code	Materiale/Material
Cod. 39D 828	Co-Polyester Elastomer

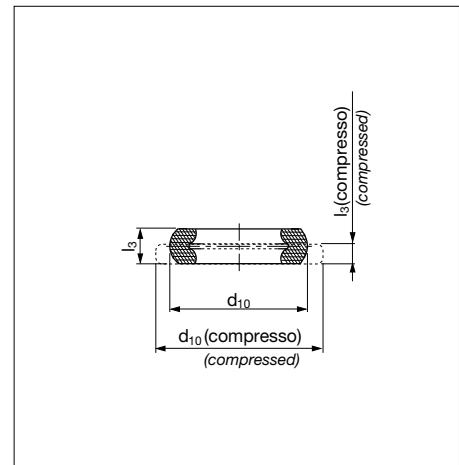

VW Code	d10 ±0,5	d10 ±0,5 compresso	l3	l3 ±0,3 compresso	Shore	Load (N)
39D 828/51	26,4	28,4	7,8±0,3	5,5	55D	5500
39D 828/52	32,1	35,1	10,8±0,3	6	72D	9000
39D 828/53	45,8	49,8	17,0±0,4	11,6	72D	20000
39D 828/54	54,6	61,8	21,3±0,4	13	55D	30000
39D 828/55	61,8	69,9	21,5±0,4	13,2	55D	46000
39D 828/56	78,5	89	29,8±0,5	17,9	55D	75000

Esempio di ordinazione/Order example = 39D 828/51 (VW code)

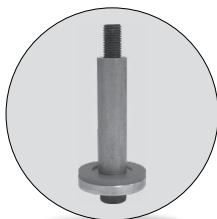

Gruppo distanziale Spacer group

Codice/Code	Materiale/Material
Cod. 39D 828	Tube/Tube: St 37
	Rondella/Washer: CK45
	Rondella in elastomero/Elastomer washer:
	Co-Polyester Elastomer

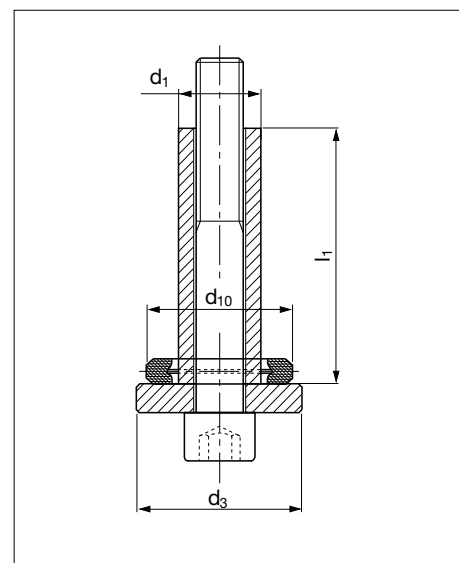

VW Code	d1x1	d3	d10	Shore	VW Code	d1x1	d3	d10	Shore
39D 828/73	16x40	30	26,4	55D	39D 828/84	25x100	50	45,8	72D
39D 828/74	16x50	30	26,4	55D	39D 828/85	25x125	50	45,8	72D
39D 828/75	16x63	30	26,4	55D	39D 828/86	30x80	65	54,6	55D
39D 828/77	16x100	30	26,4	55D	39D 828/88	30x125	65	54,6	55D
39D 828/78	20x50	35	32,1	72D	39D 828/89	36x80	70	61,8	55D
39D 828/79	20x63	35	32,1	72D	39D 828/90	36x100	70	61,8	55D
39D 828/80	20x80	35	32,1	72D	39D 828/91	36x125	70	61,8	55D
39D 828/81	20x100	35	32,1	72D	39D 828/92	42x80	90	78,5	55D
39D 828/82	25x63	50	45,8	72D	39D 828/93	42x100	90	78,5	55D
39D 828/83	25x80	50	45,8	72D	39D 828/94	42x125	90	78,5	55D

Esempio di ordinazione/Order example = 39D 828/73 (VW code)

Staffa di sollevamento con perno VW-Audi *Lifting bracket with pin VW-Audi*



Codice/Code	Materiale/Material
Cod. 39D 839	Staffa/Bracket = ST52; Perno/Pin = CK45

VW code	Carico max Max load Kg	Peso max stampo/Max. die weight	b1	l1	Forma Form
39D 839/1	8000	16000	188	290	A
39D 839/2	12500	25000	280	333	B

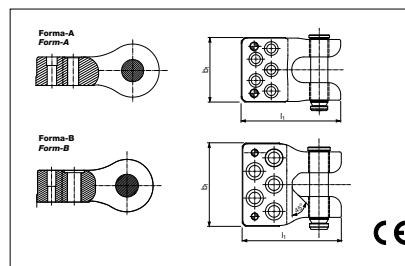

Esempio di ordinazione/Order example = 39D 839/1 (VW code)

Reazione per cilindro *Pressure plate*

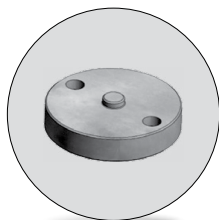

Codice/Code	Materiale/Material
Cod. 39D 847	90MnCrV8 HRC 56 ÷ 60

VW code	d1	VW code	d1
39D 847/1	98	39D 847/3	128
39D 847/2	113	39D 847/4	143

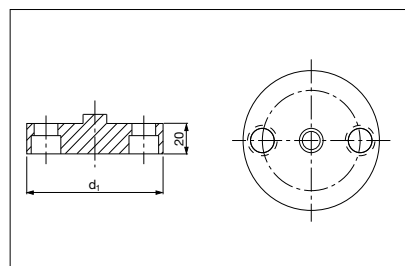

Esempio di ordinazione/Order example = 39D 847/1 (VW code)

Reazione per cilindro *Pressure plate*

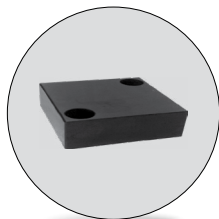

Codice/Code	Materiale/Material
Cod. 39D 847	90MnCrV8 HRC 56 ÷ 60

VW code	l	h
39D 847/10	40	12
39D 847/11	60	15
39D 847/12	70	15
39D 847/13	100	20
39D 847/14	140	20

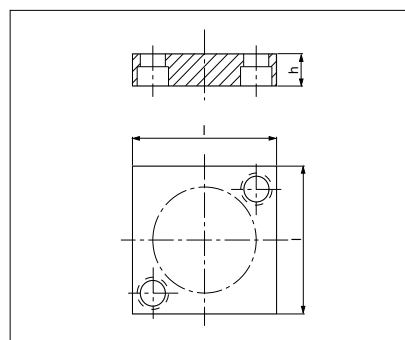

Esempio di ordinazione/Order example = 39D 847/10 (VW code)

Perno scorrevole *Sliding pin*

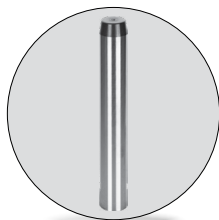

Codice/Code	Materiale/Material
Cod. 39D 851	CK45 HRC 60 ÷ 62

VW code	d1	l1
39D 851/20	20	???
39D 851/25	25	???
39D 851/30	30	???

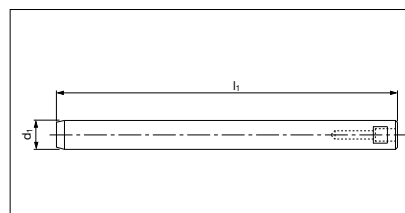

l1 da indicare in fase di ordinazione.
l1 indicate when ordering.

Esempio di ordinazione/Order example = 39D 851/20+l1 (VW code+l1)

Perno scorrevole *Sliding pin*

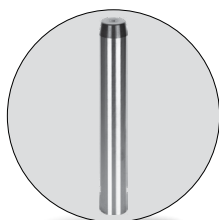

Codice/Code	Materiale/Material
Cod. 39D 851	CK45 indurito/hardened; HRC 60 ÷ 62

VW code	d1	l1
39D 851/32	30	270
39D 851/34	30	425

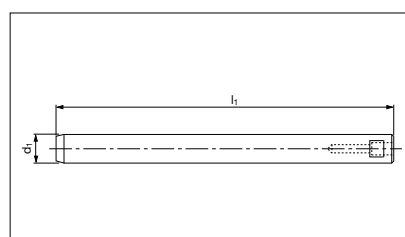

Esempio di ordinazione/Order example = 39D 851/32 (VW code)



Perno di arresto *Pad retainer pins*

Codice/Code	Materiale/Material
Cod. 39D 854	42CrMo4 1000 ÷ 1000 N/mm ²

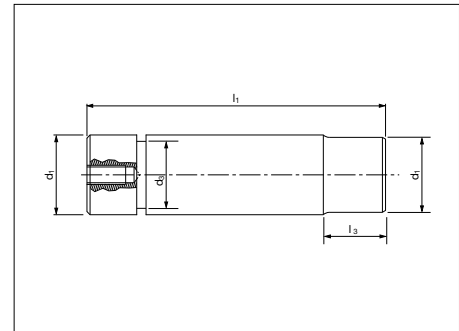

VW code	d1	l1	VW code	d1	l1
39D 854/1	32	105	39D 854/5	50	167
39D 854/2	32	122	39D 854/6	50	192
39D 854/3	40	139	39D 854/7	63	202
39D 854/4	40	159	39D 854/8	63	237

VW code	d1	l1	VW code	d1	l1
39D 854/11	32	*	39D 854/15	50	*
39D 854/21	32	*	39D 854/26	50	*
39D 854/13	40	*	39D 854/17	63	*
39D 854/23	40	*	39D 854/27	63	*

Esempio di ordinazione/Order example = 39D 854/1 (VW code)

*da indicare in fase di ordinazione.
Indicate when ordering.

Rispettare il carico max. *Respect the max load.*

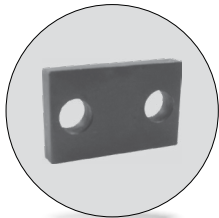

Piastrina *Retainer plate*

Codice/Code	Materiale/Material
Cod. 39D 856	Acciaio/Steel

VW code	Ø perno/pin	l1
39D 856/2	25 - 32	40
39D 856/4	40 - 50	48
39D 856/6	63 - 80	60

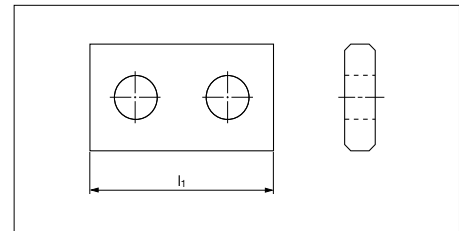

Esempio di ordinazione/Order example = 39D 856/2 (VW code)

Boccola autolubrificante DIN 9834 *Guide bushes with collar, self-lubricating DIN 9834*



Codice/Code	Materiale/Material
Cod. 39D 860	Bronzo + grafite <i>Bronze + graphite HB ≥ 190</i>

VW code	d1	l1	VW code	d1	l1
39D 860/31	25	40	39D 860/36	80	100
39D 860/32	32	50	39D 860/37	100	125
39D 860/33	40	63	39D 860/38	125	160
39D 860/34	50	71	39D 860/40	160	200
39D 860/35	63	80			

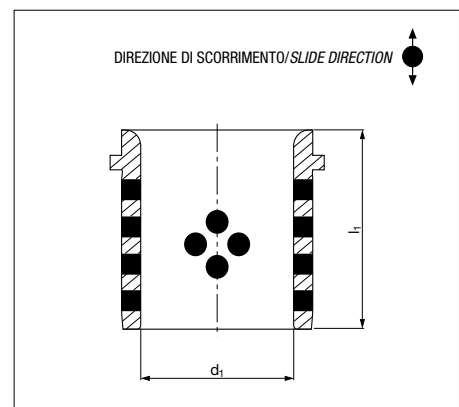

Esempio di ordinazione/Order example = 39D 860/31 (VW code)

INDEX

AUTOMOTIVE

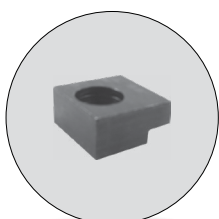

Ritegno per boccola *Toe Clamp*

Codice/Code	Materiale/Material
Cod. 39D 861	CK45

VW code	Ø boccola/bushes
39D 861/6	25 ÷ 50
39D 861/10	63 ÷ 160

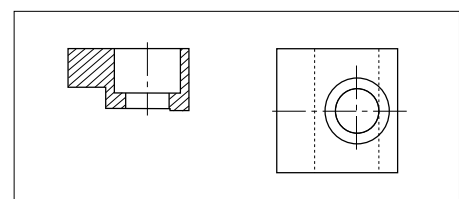

Esempio di ordinazione/Order example = 39D 861/6 (VW code)

Staffette per bussola *Clamps for bushing*

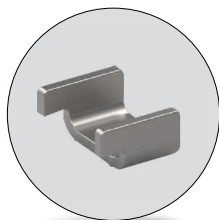

Codice/Code	Materiale/Material
Cod. 39D 861	S235JRH

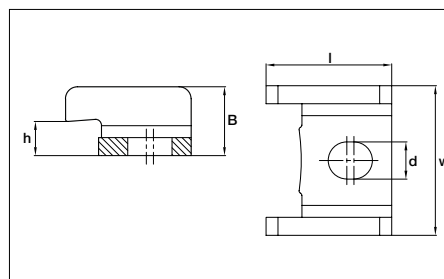

VW code	w	l	d	B	h	Ø boccola/bushes	viti
39D 861/12	25	21	6,2	11,5	5,7	Ø 25 - Ø 50	M6x15
39D 861/14	40	32	10,2	19	9,3	Ø 63 - Ø 160	M10x20

Esempio di ordinazione/Order example = 39D 861/12 (VW code)

Viti non incluse. Screws not included.

Colonna guida DIN 9833 *Guide post DIN 9833*



Codice/Code	Materiale/Material
Cod. 39D 862	16MnCr5 HRC 60 ÷ 62

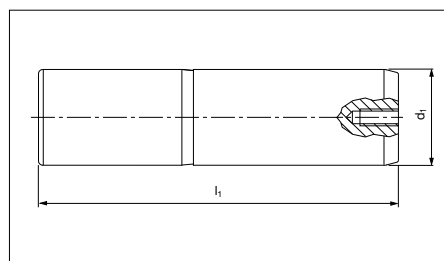

VW code	d1	l1	VW code	d1	l1	VW code	d1	l1
39D 862/13	25	125	39D 862/36	40	250	39D 862/53	63	224
39D 862/14	25	140	39D 862/37	40	280	39D 862/54	63	250
39D 862/15	25	160	39D 862/41	50	160	39D 862/55	63	280
39D 862/16	25	180	39D 862/42	50	180	39D 862/56	63	315
39D 862/23	32	140	39D 862/43	50	200	39D 862/57	63	355
39D 862/24	32	160	39D 862/44	50	224	39D 862/58	63	400
39D 862/25	32	180	39D 862/45	50	250	39D 862/62	80	224
39D 862/26	32	200	39D 862/46	50	280	39D 862/63	80	250
39D 862/31	40	140	39D 862/47	50	315	39D 862/64	80	280
39D 862/32	40	160	39D 862/48	50	355	39D 862/65	80	315
39D 862/33	40	180	39D 862/51	63	180	39D 862/66	80	355
39D 862/34	40	200	39D 862/52	63	200	39D 862/67	80	400
39D 862/35	40	224						

Esempio di ordinazione/Order example = 39D 862/13 (VW code)

Colonna guida DIN 9833 *Guide post DIN 9833*

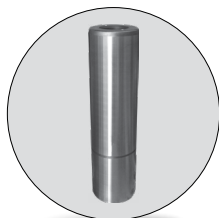

Codice/Code	Materiale/Material
Cod. 39D 862	16MnCr5 HRC 60 ÷ 62

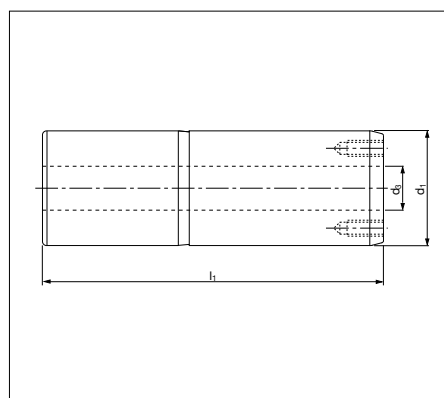

VW code	d1	d3	l1	VW code	d1	d3	l1
39D 862/73	100	50	280	39D 862/85	125	65	450
39D 862/74	100	50	315	39D 862/86	125	65	500
39D 862/75	100	50	355	39D 862/93	160	95	400
39D 862/76	100	50	400	39D 862/94	160	95	450
39D 862/82	125	65	315	39D 862/95	160	95	500
39D 862/83	125	65	355	39D 862/96	160	95	560
39D 862/84	125	65	400				

Esempio di ordinazione/Order example = 39D 862/73 (VW code)

Piastra guida autolubrificante VDI 3357 *Wear plates, self-lubricating VDI 3357*

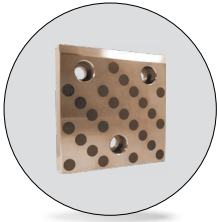

Codice/Code	Materiale/Material
Cod. 39D 863	Bronzo + grafite/Bronze + graphite HB ≥ 190

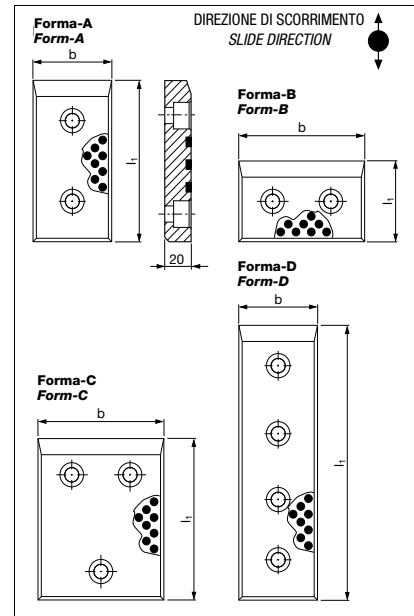

VW code	Forma/Form	b	l1	VW code	Forma/Form	b	l1
39D 863/12	A	50	80	39D 863/53	C	160	100
39D 863/13	A	50	100	39D 863/54	C	160	125
39D 863/14	A	50	125	39D 863/55	C	160	160
39D 863/15	A	50	160	39D 863/56	C	160	200
39D 863/16	A	50	200	39D 863/111	D	50	250
39D 863/21	B	80	50	39D 863/112	D	50	300
39D 863/22	A	80	80	39D 863/113	D	50	350
39D 863/23	A	80	100	39D 863/114	D	50	400
39D 863/24	A	80	125	39D 863/115	D	50	450
39D 863/25	A	80	160	39D 863/116	D	50	500
39D 863/26	A	80	200	39D 863/121	D	80	250
39D 863/31	B	100	50	39D 863/122	D	80	300
39D 863/32	B	100	80	39D 863/123	D	80	350
39D 863/33	A	100	100	39D 863/124	D	80	400
39D 863/34	A	100	125	39D 863/125	D	80	450
39D 863/35	A	100	160	39D 863/126	D	80	500
39D 863/36	A	100	200	39D 863/131	D	100	450
39D 863/41	B	125	50	39D 863/132	D	100	500
39D 863/42	B	125	80	39D 863/141	D	125	450
39D 863/43	C	125	100	39D 863/142	D	125	500
39D 863/44	C	125	125	39D 863/150	D	100	250
39D 863/45	C	125	160	39D 863/151	D	100	300
39D 863/46	C	125	200	39D 863/152	D	100	350
39D 863/51	B	160	50	39D 863/153	D	100	400
39D 863/52	B	160	80	39D 863/155	D	125	250

VW code	Forma/Form	b	l1
39D 863/156	D	125	300
39D 863/157	D	125	350
39D 863/158	D	125	400
39D 863/160	D	160	250
39D 863/161	D	160	300
39D 863/162	D	160	350
39D 863/163	D	160	400
39D 863/164	D	160	450
39D 863/165	D	160	500

Esempio di ordinazione/Order example = 39D 863/12 (VW code)

Forma D: non a norma VDI 3357.
Form D not in accordance with VDI 3357.

INDEX

Piastra guida in acciaio VDI 3357 *Wear plates, steel VDI 3357*

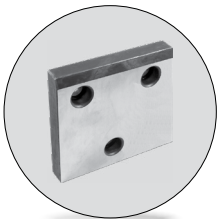

Codice/Code	Materiale/Material
Cod. 39D 863	16MnCr5 HRC 58 ÷ 62

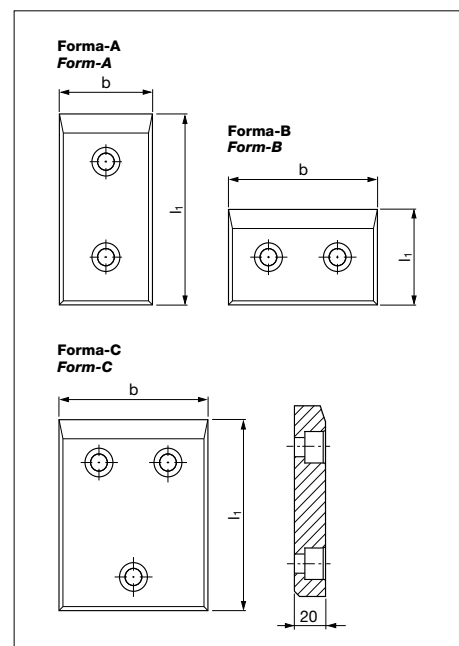

VW code	Forma/Form	b	l1	VW code	Forma/Form	b	l1
39D 863/62	A	50	80	39D 863/85	A	100	160
39D 863/63	A	50	100	39D 863/86	A	100	200
39D 863/64	A	50	125	39D 863/91	B	125	50
39D 863/65	A	50	160	39D 863/92	B	125	80
39D 863/66	A	50	200	39D 863/93	C	125	100
39D 863/71	B	80	50	39D 863/94	C	125	125
39D 863/72	A	80	80	39D 863/95	C	125	160
39D 863/73	A	80	100	39D 863/96	C	125	200
39D 863/74	A	80	125	39D 863/101	B	160	50
39D 863/75	A	80	160	39D 863/102	B	160	80
39D 863/76	A	80	200	39D 863/103	C	160	100
39D 863/81	B	100	50	39D 863/104	C	160	125
39D 863/82	B	100	80	39D 863/105	C	160	160
39D 863/83	A	100	100	39D 863/106	C	160	200
39D 863/84	A	100	125				

Esempio di ordinazione/Order example = 39D 863/62 (VW code)

Perno di sollevamento *Lifting pin*



Codice/Code	Materiale/Material
Cod. 39D 866	d1 ≤ 63 CK45 d1 = 76 42CrMo4

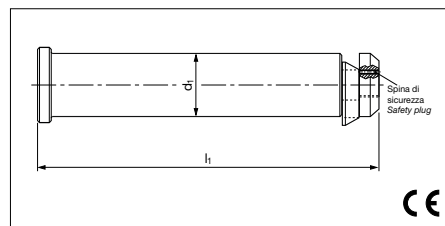

Attenzione: per ragioni di sicurezza, il peso dello stampo deve essere sopportato da 2 soli perni.
For safety, consider that the weight of the die has to be supported just by 2 lifting pins.

VW Code	Carico max Max load (Kg)	Peso max stampo Max. die weight (Kg)	d1	l1
39D 866/3	3200	6400	32	175
39D 866/4	5000	10000	40	225
39D 866/5	8000	16000	50	273
39D 866/6	12500	25000	63	347
39D 866/7	31500	63000	76	422
39D 866/25	8000	16000	50	221
39D 866/26	12500	25000	63	277

Esempio di ordinazione/Order example = 39D 866/3 (VW code)

Rispettare il carico max. *Respect the max load.*

Rondella *Washer*

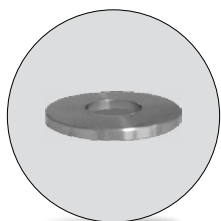

Codice/Code	Materiale/Material
Cod. 39D 869	CK45

VW code	d1
39D 869/3	35
39D 869/4	40
39D 869/5	50
39D 869/6	65
39D 869/8	80
39D 869/10	100
39D 869/13	130

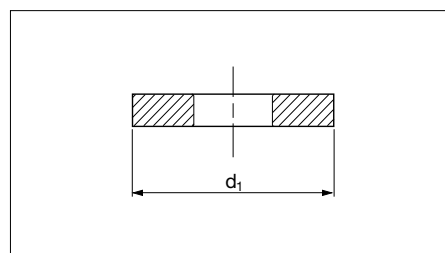

Esempio di ordinazione/Order example = 39D 869/3 (VW code)

Fissaggio cilindro *Air cylinder fixing*

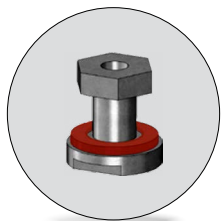

Codice/Code	Materiale/Material
Cod. 39D 870	CK45 ed Elastomero/ <i>and Elastomer</i> 90 SH.

VW code	d1	h1
39D 870/16	M16x1,5	57
39D 870/20	M20x1,5	63
39D 870/27	M27x2,0	65

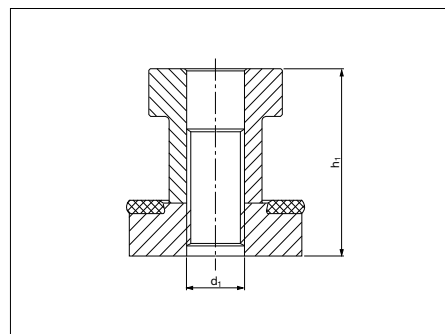

Esempio di ordinazione/Order example = 39D 870/16 (VW code)

Supporto con rullo *Cam roller*



Codice/Code	Materiale/Material
Cod. 39D 872	Acciaio/Steel

VW code	
39D 872/20	
39D 872/21	

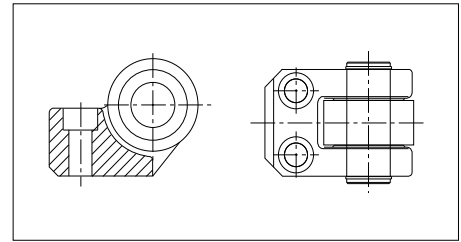

Esempio di ordinazione/Order example = 39D 872/20 (VW code)

Camma di accelerazione *Acceleration cam*

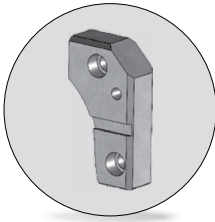

Codice/Code	Materiale/Material
Cod. 39D 873	90MnCrV8 HRC 60 ÷ 62

VW code	Lato/Side	W1	R1
39D 873/10	Destro/Right	???	???
39D 873/11	Sinistro/Left	???	???

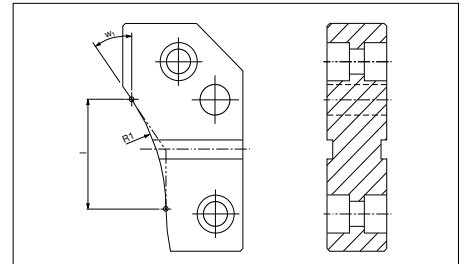

W1 e R1 da indicare in fase di ordinazione.
W1 and R1 indicate when ordering.

Esempio di ordinazione/Order example = 39D 873/10+W1+R1 (VW code+W1+R1)

Staffa di sollevamento VDI 3366 *Lifting brackets VDI 3366*

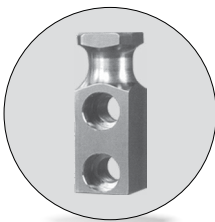

Codice/Code	Materiale/Material
Cod. 39D 876	CK45 700 ÷ 800 N/mm ²

Attenzione: per ragioni di sicurezza, il peso dello stampo deve essere sopportato da 2 sole staffe.
For safety, consider that the weight of the die has to be supported just by 2 lifting brackets.

VW code	Carico max Max load (Kg)	Peso max stampo Max. die weight (Kg)	Forma Form	l1
39D 876/10	320	640	A	80
39D 876/11	630	1260	A	90
39D 876/12	1250	2500	A	100
39D 876/13	2000	4000	A	120
39D 876/14	3200	6400	A	140
39D 876/15	5000	10000	A	160
39D 876/16	8000	16000	B	200
39D 876/17	12500	25000	B	250
39D 876/18	20000	40000	B	300

Viti non incluse/Screws not included

Esempio di ordinazione/Order example = 39D 876/10 (VW code)

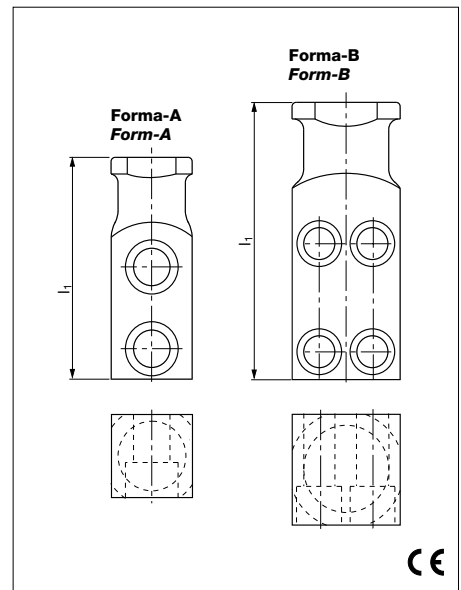

Rispettare il carico max. Respect the max load.

INDEX

AUTOMOTIVE

Fissaggio cilindro *Air cylinder fixing*

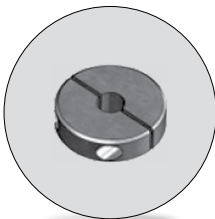

Codice/Code	Materiale/Material
Cod. 39D 882	34Cr4

VW code	
39D 882/2	

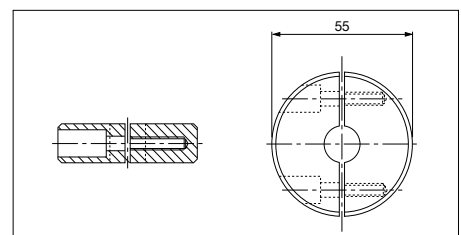

Esempio di ordinazione/Order example = 39D 882/2 (VW code)

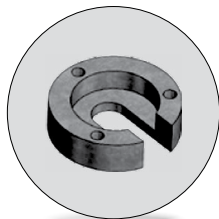

Fissaggio cilindro *Air cylinder fixing*

Codice/Code	Materiale/Material
Cod. 39D 882	CK45

VW code
39D 882/3

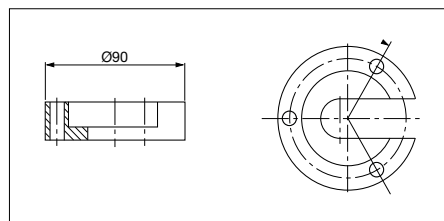

Esempio di ordinazione/Order example = 39D 882/3 (VW code)

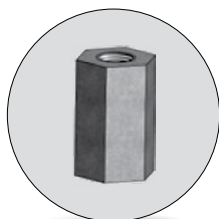

Adattatore per cilindro *Air cylinder adapter*

Codice/Code	Materiale/Material
Cod. 39D 887	CK45

VW code
39D 887/1

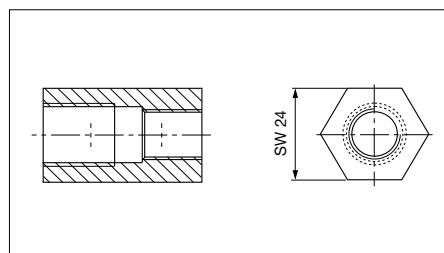

Esempio di ordinazione/Order example = 39D 887/1 (VW code)

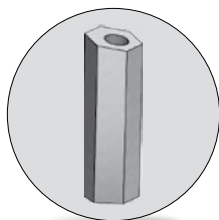

Adattatore per cilindro *Air cylinder adapter*

Codice/Code	Materiale/Material
Cod. 39D 887	CK45

VW code	l	w
39D 887/2	???	???

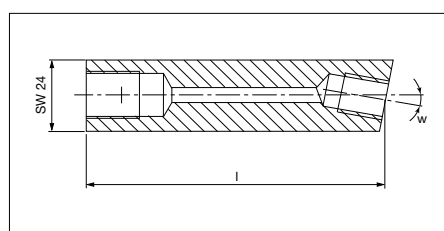

$l \max = 100$

l e w da indicare in fase di ordinazione.
l e *w* indicate when ordering.

Esempio di ordinazione/Order example = 39D 887/2+l+w (VW code+l+w)



Piastra guida autolubrificante *Wear plates, self-lubricating*

Codice/Code	Materiale/Material
Cod. 39D 890	Bronzo + grafite <i>Bronze + graphite</i> HB ≥ 190

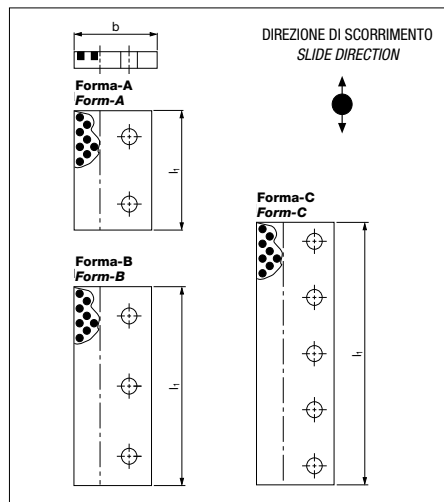

VW code	b	l1	Forma Form	VW code	b	l1	Forma Form
39D 890/25	85	160	A	39D 890/16	125	200	A
39D 890/26	85	200	A	39D 890/17	125	250	B
39D 890/27	85	250	B	39D 890/18	125	300	B
39D 890/28	85	300	B	39D 890/19	125	350	B
39D 890/29	85	350	B	39D 890/20	125	400	C
39D 890/30	85	400	C	39D 890/21	125	450	C
39D 890/15	125	160	A	39D 890/22	125	500	C

Esempio di ordinazione/Order example = 39D 890/25 (VW code)

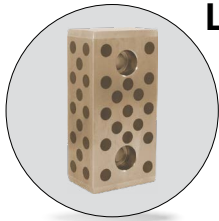

Lardone autolubrificante vdi 3357 *Wear strip with two slide surfaces VDI 3357*

Codice/Code	Materiale/Material
Cod. 39D 892	Bronzo + grafite <i>Bronze + graphite</i> HB ≥ 190

VW code	b	l1	VW code	b	l1
39D 892/10	A	125	39D 892/15	A	125
39D 892/11	A	160	39D 892/16	A	160
39D 892/12	B	200	39D 892/17	B	200

Esempio di ordinazione/Order example = 39D 892/10 (VW code)

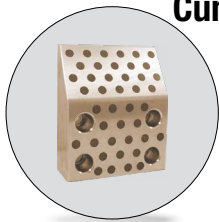
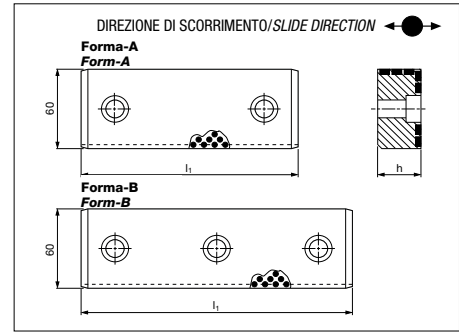

Cuneo autolubrificante VDI 3357 *Cam dwell wear plate, self-lubricating VDI 3357*

Codice/Code	Materiale/Material
Cod. 39D 894	Bronzo + grafite <i>Bronze + graphite</i> HB ≥ 190

VW code	b	l	t	VW code	b	l	t
39D 894/130	100	170	45	39D 894/136	125	150	45
39D 894/131	125	170	45	39D 894/137	125	170	60
39D 894/132	150	170	45	39D 894/138	150	150	45
39D 894/133	200	170	45	39D 894/139	150	170	60
39D 894/134	100	150	45	39D 894/140	200	150	45
39D 894/135	100	170	60	39D 894/141	200	170	60

Esempio di ordinazione/Order example = 39D 894/130 (VW code)

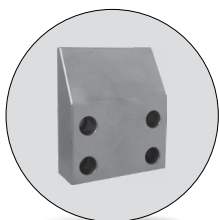
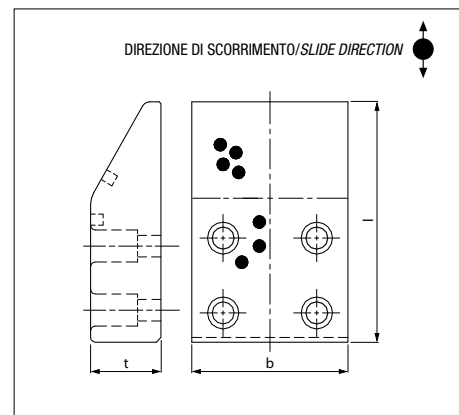

Cuneo in acciaio VDI 3357 *Cam dwell wear plate, steel VDI 3357*

Codice/Code	Materiale/Material
Cod. 39D 894	X155CrVMo12Ku HRC 58 ÷ 62

VW code	b	l	t	VW code	b	l	t
39D 894/150	100	170	45	39D 894/156	125	150	45
39D 894/151	125	170	45	39D 894/157	125	170	60
39D 894/152	150	170	45	39D 894/158	150	150	45
39D 894/153	200	170	45	39D 894/159	150	170	60
39D 894/154	100	150	45	39D 894/160	200	150	45
39D 894/155	100	170	60	39D 894/161	200	170	60

Esempio di ordinazione/Order example = 39D 894/150 (VW code)

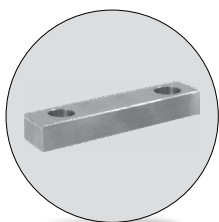
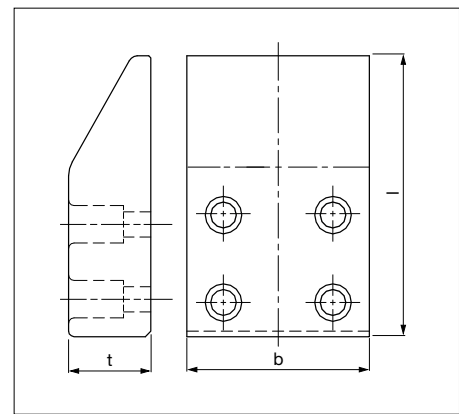

Chiavetta *Key*

Codice/Code	Materiale/Material
Cod. 39D 895	S235JRG2K

VW code	VW code	l1	l2
**39D 895/1	39D 895/11	80	40
**39D 895/2	39D 895/12	120	80
**39D 895/3	39D 895/13	200	160

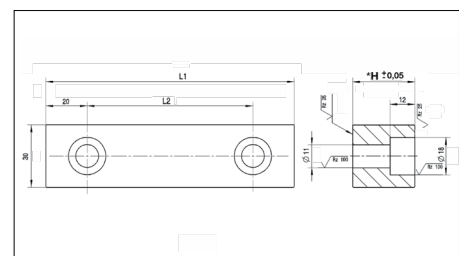

Esempio di ordinazione/Order example = 39D 895/1 (VW code)

*Indicare in fase di ordinazione. *Indicate when ordering*
*Solo ricambi/Only for replacement

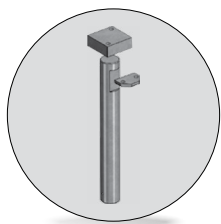

Gruppo perno di compensazione *Compensation pin group*

Codice/Code	Materiale/Material
Cod. 39D 896	16MnCr5 HRC 60 ÷ 64
VW code	
39D 896/1	

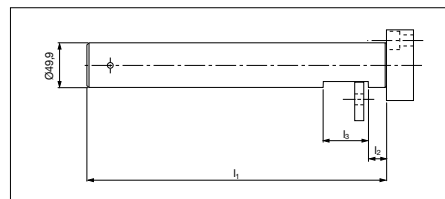

l1, l2 e l3 da indicare in fase di ordinazione.
l1, l2 e l3 indicate when ordering.

Esempio di ordinazione/Order example = 39D 896/1+l1+l2+l3 (VW code+l1+l2+l3)

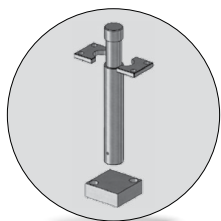

Gruppo perno di compensazione *Compensation pin group*

Codice/Code	Materiale/Material
Cod. 39D 896	16MnCr5; HRC 60 ÷ 64
VW code	
39D 896/2	

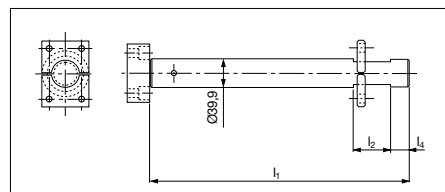

l1, l2 e l4 da indicare in fase di ordinazione.
l1, l2 e l4 indicate when ordering.

Esempio di ordinazione/Order example = 39D 896/2+l1+l2+l4 (VW code+l1+l2+l4)

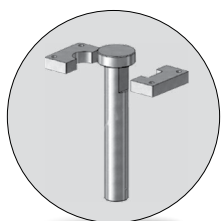

Gruppo perno di compensazione *Compensation pin group*

Codice/Code	Materiale/Material
Cod. 39D 896	16MnCr5; HRC 60 ÷ 64
VW code	
39D 896/3	

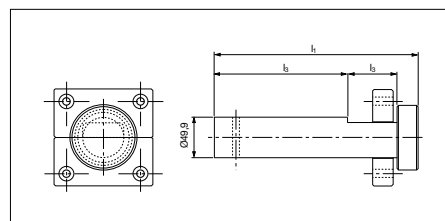

l1, l2 e l3 da indicare in fase di ordinazione.
l1, l2 e l3 indicate when ordering.

Esempio di ordinazione/Order example = 39D 896/3+l1+l2+l3 (VW code+l1+l2+l3)

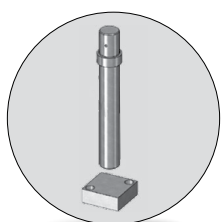

Gruppo perno di compensazione *Compensation pin group*

Codice/Code	Materiale/Material
Cod. 39D 896	16MnCr5; HRC 60 ÷ 64
VW code	
39D 896/4	

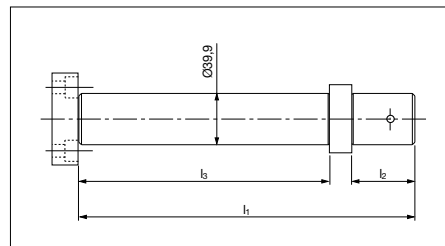

l1, l2 e l3 da indicare in fase di ordinazione.
l1, l2 e l3 indicate when ordering.

Esempio di ordinazione/Order example = 39D 896/4+l1+l2+l3 (VW code+l1+l2+l3)

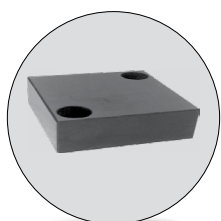

Reazione per cilindro *Pressure plate*

Codice/Code	Materiale/Material
Cod. 39D 896	16MnCr5; HRC 60 ÷ 64
VW code	
39D 896/1-02	

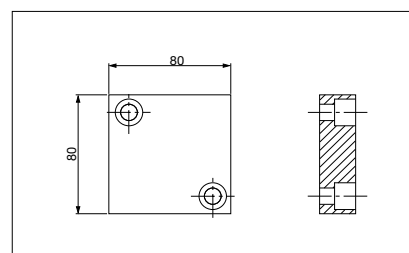

Esempio di ordinazione/Order example = 39D 896/1-02 (VW code)

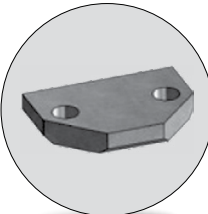

Piastrina Retainer

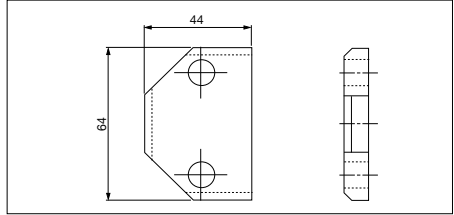

Codice/Code	Materiale/Material
Cod. 39D 896	16MnCr5; HRC 60 ÷ 64
VW code	
39D 896/1-03	

Esempio di ordinazione/Order example = 39D 896/1-03 (VW code)

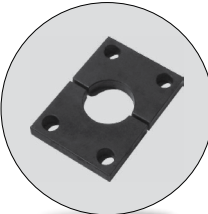

Piastrina Retainer

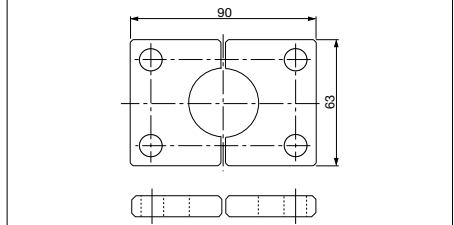

Codice/Code	Materiale/Material
Cod. 39D 896	16MnCr5; HRC 60 ÷ 64
VW code	
39D 896/2-03	
39D 896/2-04	

Esempio di ordinazione/Order example = 39D 896/2-03 (VW code)

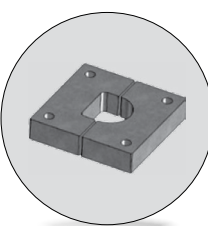

Piastrina Retainer

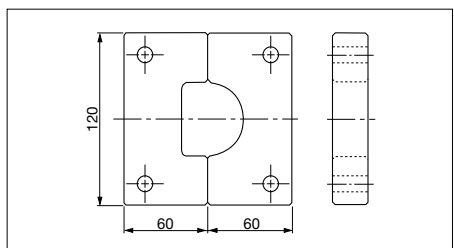

Codice/Code	Materiale/Material
Cod. 39D 896	16MnCr5; HRC 60 ÷ 64
VW code	
39D 896/3-03	
39D 896/3-04	

Esempio di ordinazione/Order example = 39D 896/3-03 (VW code)

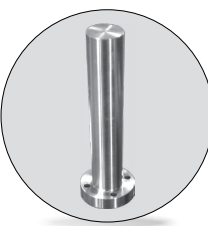

Candela Air pin

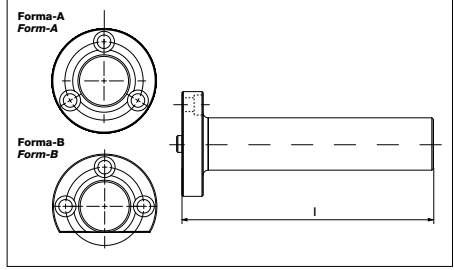

Codice/Code	Materiale/Material
Cod. 39D 951	42CrMo4 Lmax= 440
VW code	Forma/Form
*39D 951/1	A
*39D 951/2	B
39D 951/11	A
39D 951/12	B

Esempio di ordinazione/Order example = 39D 951/1+I (VW code+I)

I da indicare in fase di ordinazione. *I indicate when ordering*
*Solo ricambi/Only for replacement

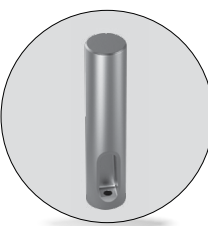

Candela Air pin

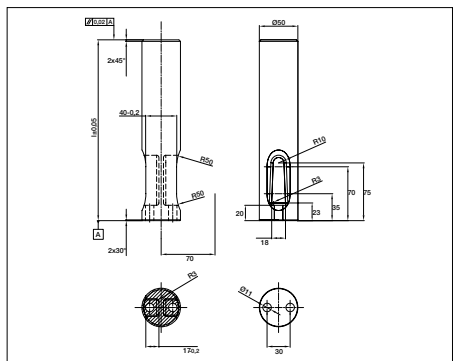

Codice/Code	Materiale/Material
Cod. 39D 951/21	1.7227 (42CrMoS4+QT)

I da indicare in fase di ordinazione. *I indicate when ordering*

VW code	I	Carico max Max load
39D 951/21	???	80

Esempio di ordinazione/Order example = 39D 951/21+I (VW code+I)

Guida a "V" in acciaio VDI 3357 "V" driver, steel VDI 3357

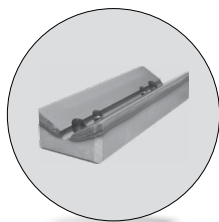

Codice/Code	Materiale/Material
Cod. 39D 952	CK45 HRC 58 ÷ 60

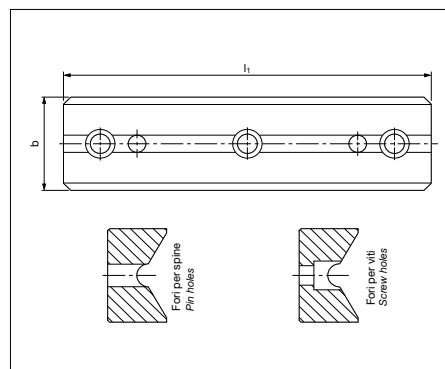

VW code	b	l1	VW code	b	l1
39D 952/10	65	150	39D 952/20	125	150
39D 952/11	65	200	39D 952/21	125	200
39D 952/12	65	250	39D 952/22	125	250
39D 952/13	65	300	39D 952/23	125	300

Esempio di ordinazione/Order example = 39D 952/10 (VW code)

Guida a "V" autolubrificante VDI 3357 "V" driver, self-lubricating VDI 3357

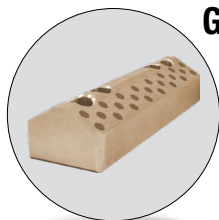

Codice/Code	Materiale/Material
Cod. 39D 952	Bronzo + grafite Bronze + graphite HB ≥ 190

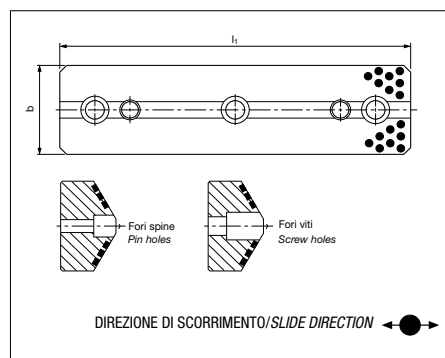

VW code	b	l1	VW code	b	l1
39D 952/40	65	150	39D 952/50	125	150
39D 952/41	65	200	39D 952/51	125	200
39D 952/42	65	250	39D 952/52	125	250
39D 952/43	65	300	39D 952/53	125	300

Esempio di ordinazione/Order example = 39D 952/40 (VW code)

Piastra guida autolubrificante VDI 3357 Wear plates, self-lubricating VDI 3357



Codice	Materiale/Material
Cod. 39D 954	Bronzo + grafite Bronze + graphite HB ≥ 190

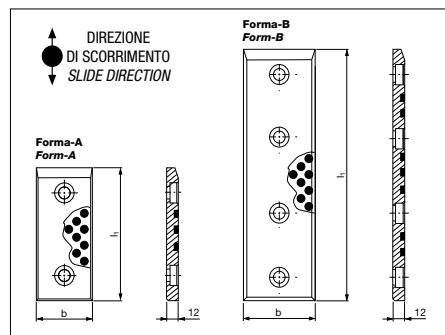

VW code	Forma/Form	b	l1	VW code	Forma/Form	b	l1	VW code	Forma/Form	b	l1
39D 954/11	A	30	80	39D 954/21	A	50	80	39D 954/31	A	80	80
39D 954/12	A	30	100	39D 954/22	A	50	100	39D 954/32	A	80	100
39D 954/13	A	30	125	39D 954/23	A	50	125	39D 954/33	A	80	125
39D 954/14	A	30	160	39D 954/24	A	50	160	39D 954/34	A	80	160
39D 954/15	A	30	200	39D 954/25	A	50	200	39D 954/35	A	80	200
39D 954/16	A	40	80	39D 954/26	A	60	80	39D 954/36	B	50	250
39D 954/17	A	40	100	39D 954/27	A	60	100	39D 954/37	B	50	300
39D 954/18	A	40	125	39D 954/28	A	60	125	39D 954/38	B	50	350
39D 954/19	A	40	160	39D 954/29	A	60	160	39D 954/39	B	50	400
39D 954/20	A	40	200	39D 954/30	A	60	200				

Esempio di ordinazione/Order example = 39D 954/11 (VW code)



Piastra guida in acciaio VDI 3357 *Wear plates, steel VDI 3357*

Codice/Code	Materiale/Material
Cod. 39D 954	16MnCr5 - HRC 60 ÷ 64

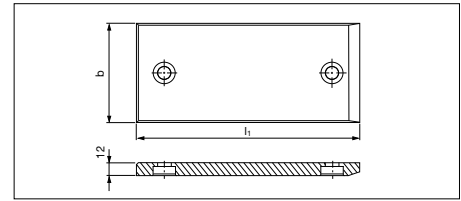

VW code	b	l	VW code	b	l	VW code	b	l	VW code	b	l
39D 954/41	30	80	39D 954/48	40	125	39D 954/54	50	160	39D 954/60	60	200
39D 954/42	30	100	39D 954/49	40	160	39D 954/55	50	200	39D 954/61	80	80
39D 954/43	30	125	39D 954/50	40	200	39D 954/56	60	80	39D 954/62	80	100
39D 954/44	30	160	39D 954/51	50	80	39D 954/57	60	100	39D 954/63	80	125
39D 954/45	30	200	39D 954/52	50	100	39D 954/58	60	125	39D 954/64	80	160
39D 954/46	40	80	39D 954/53	50	125	39D 954/59	60	160	39D 954/65	80	200
39D 954/47	40	100									

Esempio di ordinazione/Order example = 39D 954/41 (VW code)



Boccola autolubrificante *Guide bushes, self-lubricating*

Codice/Code	Materiale/Material
Cod. 39D 956	Bronzo + grafite/Bronze + graphite HB ≥ 190

VW code	l
39D 956/1	115
39D 956/2	145
39D 956/3	170

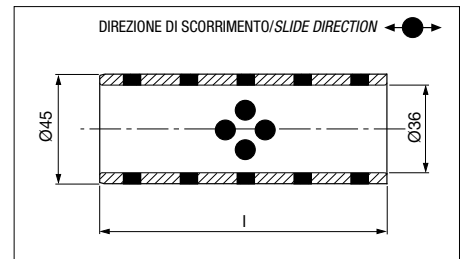

Esempio di ordinazione/Order example = 39D 956/1 (VW code)

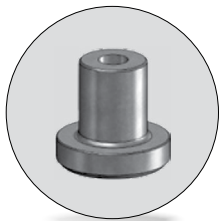

Perno di arresto *Stop pin*

Codice/Code	Materiale/Material
Cod. 39D 958	42CrMo4

VW code	d1
39D 958/1	100
39D 958/2	80

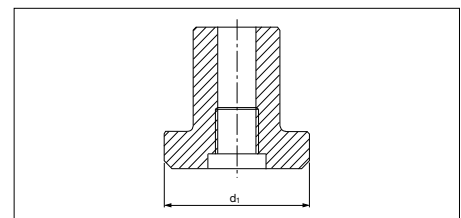

Esempio di ordinazione/Order example = 39D 958/1 (VW code)



Colonna guida tipo DIN 9833 *Guide post DIN 9833*

Codice/Code	Materiale/Material
Cod. 39D 969	16MnCr5 HRC 60 ÷ 64

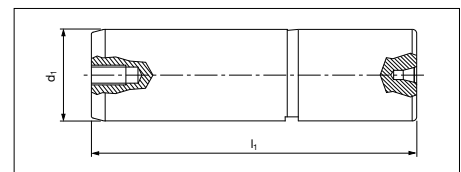

VW code	d1	l1	VW code	d1	l1	VW code	d1	l1	VW code	d1	l1	VW code	d1	l1
39D 969/13	25	125	39D 969/26	32	200	39D 969/37	40	280	39D 969/48	50	355	39D 969/58	63	400
39D 969/14	25	140	39D 969/32	40	160	39D 969/43	50	200	39D 969/53	63	224	39D 969/64	80	250
39D 969/15	25	160	39D 969/33	40	180	39D 969/44	50	224	39D 969/54	63	250	39D 969/65	80	280
39D 969/16	25	180	39D 969/34	40	200	39D 969/45	50	250	39D 969/55	63	280	39D 969/66	80	315
39D 969/23	32	140	39D 969/35	40	224	39D 969/46	50	280	39D 969/56	63	315	39D 969/67	80	355
39D 969/24	32	160	39D 969/36	40	250	39D 969/47	50	315	39D 969/57	63	355	39D 969/68	80	400
39D 969/25	32	180												

Esempio di ordinazione/Order example = 39D 969/13 (VW code)

Sollevatore *Lifter*

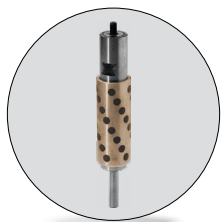

Codice/Code	Materiale/Material
Cod. 39D 972	Acciaio trattato/Treated steel

VW code	l1
39D 972/11	182
39D 972/12	200
39D 972/13	220

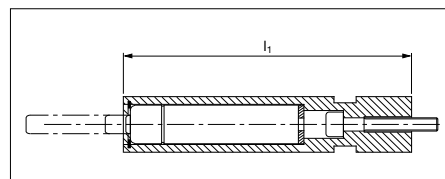

Il codice comprende: canotto, rondella, brugola e seeger.
Il cilindro azoto e la boccia vanno ordinati separatamente.
The code includes: tube, washer, screw and seeger.
The nitrogen cylinder and bushing must be ordered separately.

Esempio di ordinazione/Order example = 39D 972/11 (VW code)

Tassello di compensazione *Spacer plates, toothed with adjusting plate*

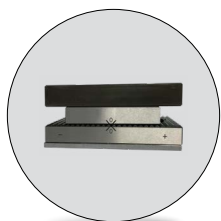

Codice/Code	Materiale/Material
Cod. 39D 976	90MnCrV8; HRC 58 ÷ 60

VW code	b	l
39D 976-10	60	130
39D 976-11	80	160

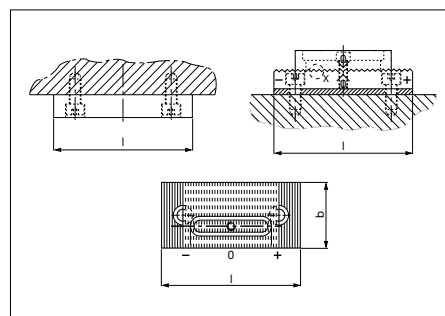

Esempio di ordinazione/Order example = 39D 976-10 (VW code)

Piastrina portasensore *Plate for sensor*



Codice/Code	Materiale/Material
Cod. 39D 993	Acciaio/Steel

VW code	d1
39D 993/1	19
39D 993/2	31

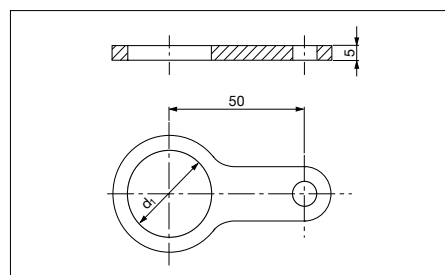

Esempio di ordinazione/Order example = 39D 993/1 (VW code)

Distanziale *Spacer*

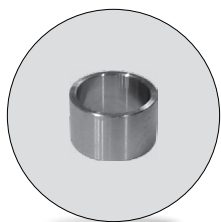

Codice/Code	Materiale/Material
Cod. 39D 995	CK45

VW code
39D 995/4

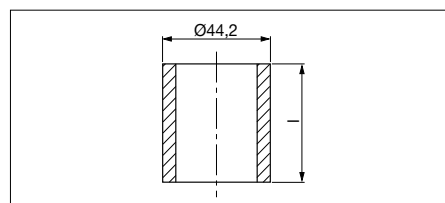

l1 da indicare in fase di ordinazione.
l1 indicate when ordering.

Esempio di ordinazione/Order example = 39D 995/4+l1 (VW code+l1)

Rondella *Washer*

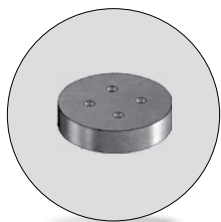

Codice/Code	Materiale/Material
Cod. 39D 995	CK45

VW code
39D 995/5

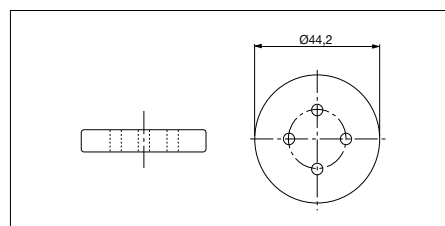

Esempio di ordinazione/Order example = 39D 995/5 (VW code)

Tassello *Stop block*

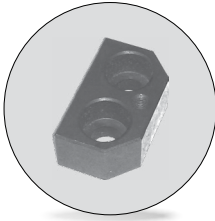

Codice/Code	Materiale/Material
Cod. 39D 995	16MnCr5 HRC 60 ÷ 62

VW code	
39D 995/6	
39D 995/7	

*Adattare in fase di montaggio/Adjust during assembly

Esempio di ordinazione/Order example = 39D 995/6 (VW code)

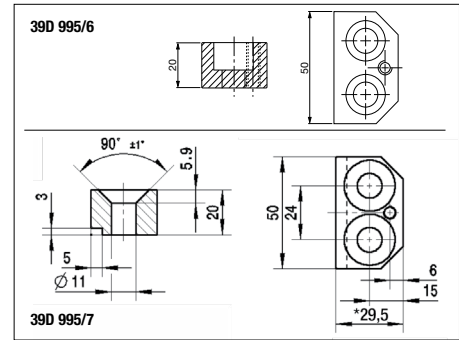

Perno con rondella *Retainer bolt sets*



Codice/Code	Materiale/Material
Cod. 39D 995	Vite/Screw = DIN 912 Rondella/Washer = acciaio/steel Anello/Ring = nylatron GSM P30

VW code	I1	VW code	I1
39D 995/12	120	39D 995/15	150
39D 995/14	135	39D 995/16	160

Esempio di ordinazione/Order example = 39D 995/12 (VW code)

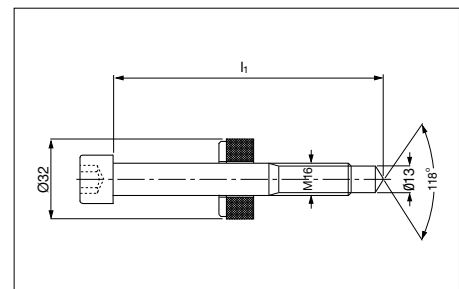

Guida a V con piastre di scorrimento intercambiabili e ritorno di sicurezza

“V” driver sets with replaceable inserts with positive return

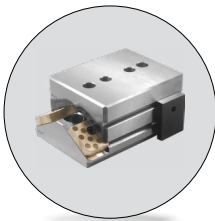

Codice/Code	Materiale/Material
Cod. 39D 996	Blocco femmina/Female block: CK45; HRC 60 ÷ 64 Blocco maschio/Male block: CK45 Piastrine intercambiabili/Replaceable inserts: bronzo + grafite/Bronze + graphite HB ≥ 190 Ritorno di sicurezza/Positive return: acciaio/steel HRC 40 ÷ 45

B - C vanno indicate in fase di ordinazione.
B-C indicate when ordering.

VW code	b	h	l	VW code	b	h	l
39D 996/1	65	65	150	39D 996/5	125	85	150
39D 996/2	65	65	200	39D 996/6	125	85	200
39D 996/3	65	65	250	39D 996/7	125	85	250
39D 996/4	65	65	300	39D 996/8	125	85	300

Esempio di ordinazione/Order example = 39D 996/1+B+C (VW code+B+C)

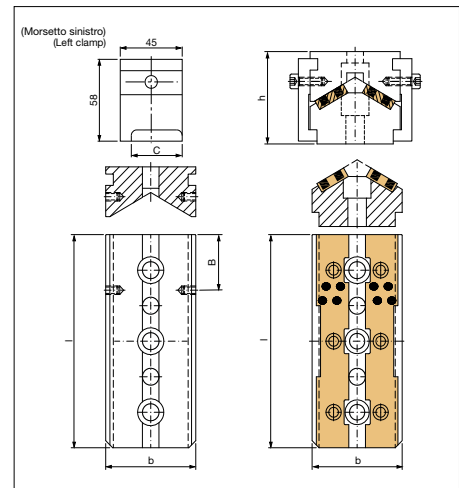

INDEX

AUTOMOTIVE

Distributore *Distributor*

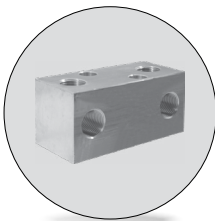

Codice/Code	Materiale/Material
Cod. 39D 1392	Ms65

VW code	I1	I2
39D 1392/1	90	40
39D 1392/2	100	45
39D 1392/3	110	50
39D 1392/4	120	60

Esempio di ordinazione/Order example = 39D 1392/1 (VW code)

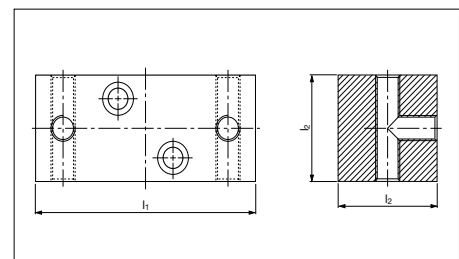

Distributore *Distributor*

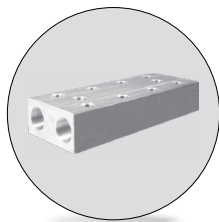

Codice/Code	Materiale/Material
Cod. 39D 1430	Ms65

VW code
39D 1430

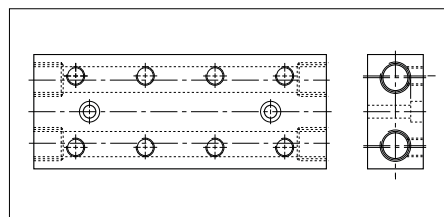

Esempio di ordinazione/Order example = 39D 1430 (VW code)

Punzone di visualizzazione *Visual locator setting punch*



Codice/Code	Materiale/Material
Cod. 39V 863	X155CrVMo12 HRC 60 ÷ 62

VW code	d1	d2
39V 863/10	10	9,7
39V 863/13	13	12

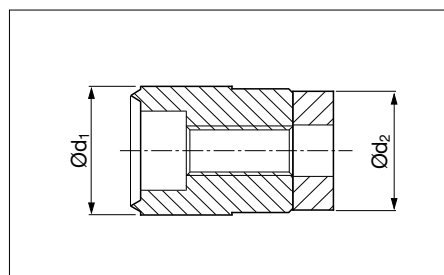

Esempio di ordinazione/Order example = 39V 863/10 (VW code)

Boccola filettata *Threaded bush*

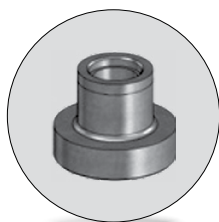

Codice/Code	Materiale/Material
Cod. 39V 1071	CK45

VW code	l1
39V 1071/1	50
39V 1071/2	87

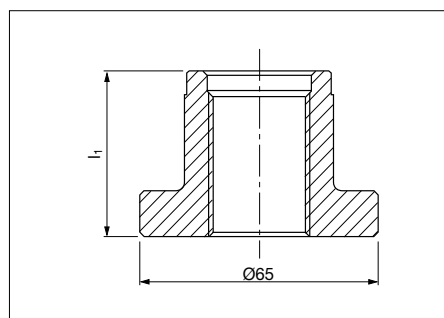

Esempio di ordinazione/Order example = 39V 1071/1 (VW code)

Blocco guida autolubrificante in acciaio *Removable die heels, steel and self-lubricating* VDI 3387

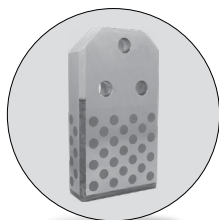

Codice/Code	Materiale/Material
Cod. 39V 1159	CK45 + grafite/graphite HRC 58 ÷ 60

VW code	Forma	a	b	l1
39V1159/24	A	112	45	250
39V1159/25	B	140	45	315
39V1159/32	B	190	56	400
39V1159/35	B	240	56	500
39V1159/36	B	240	56	630
39V1159/37	B	140	45	400
39V1159/38	B	140	56	400

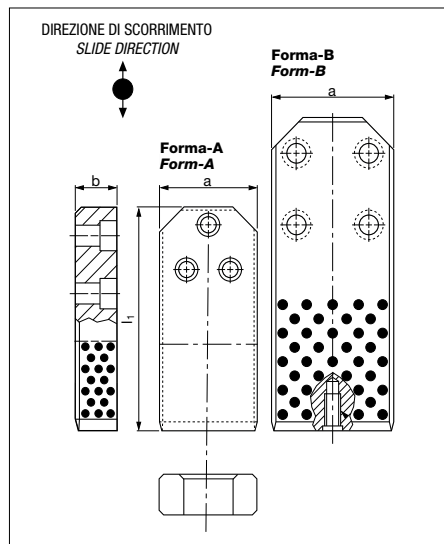

Esempio di ordinazione/Order example = 39V1159/24 (VW code)

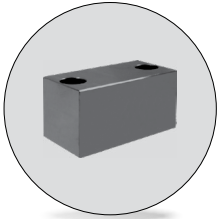

Distanziale *Stop block*

Codice/Code	Materiale/Material
Cod. 39V 1162	CK45

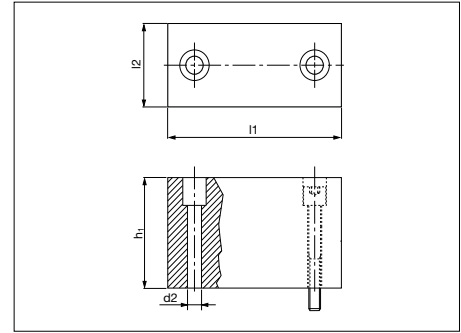

VW code	l1	l2	h1	d2	VW code	l1	l2	h1	d2
39V 1162/1	60	40	???	9	39V 1162/5	120	60	???	14
39V 1162/2	80	40	???	11	39V 1162/20	150	80	???	18
39V 1162/3	100	40	???	14	39V 1162/21	160	100	???	18
39V 1162/4	100	50	???	14					

Esempio di ordinazione/Order example = 39V 1162/1+h1 (VW code+h1)

h1 da indicare in fase di ordinazione.
h1 indicate when ordering.

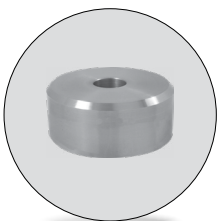

Distanziale *Stop block*

Codice/Code	Materiale/Material
Cod. 39V 1162	CK45

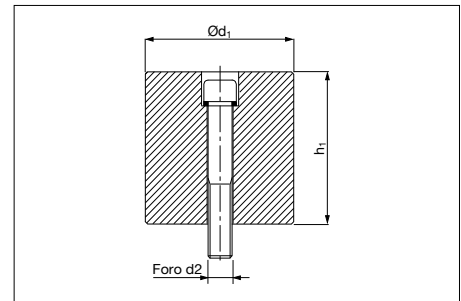

VW code	d1	d2	h1
39V 1162/14	60	14	???
39V 1162/15	80	14	???
39V 1162/17	120	18	???
39V 1162/18	150	22	???
39V 1162/25	100	22	???
39V 1162/26	80	18	???

Esempio di ordinazione/Order example = 39V 1162/14+h1 (VW code+h1)

h1 da indicare in fase di ordinazione.
h1 indicate when ordering.

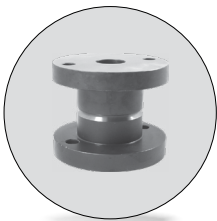

Cono di centraggio *Locating cone*

Codice/Code	Materiale/Material
Cod. 39V 1168	16MnCr5; HRC 58 - 62 Piastrina/Retainer: CK45

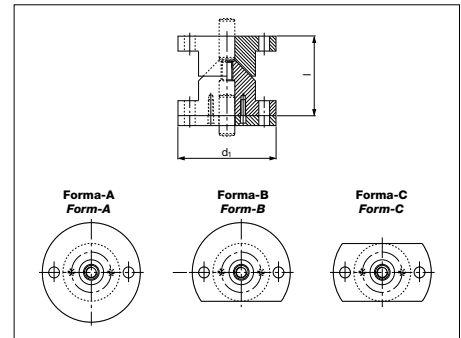

VW code	Forma/Form	d1	l	VW code	Forma/Form	d1	l
39V 1168/10	A	100	80	39V 1168/16	B	120	90
39V 1168/12	A	120	90	39V 1168/18	C	100	80
39V 1168/14	B	100	80	39V 1168/20	C	120	90

Esempio di ordinazione/Order example = 39V 1168/10 (VW code)

INDEX

AUTOMOTIVE



Perno di sollevamento VDI 3366 *Lifting pins VDI 3366*

Codice/Code	Materiale/Material
Cod. 39V 1199	CK45 700 ÷ 800 N/mm ²

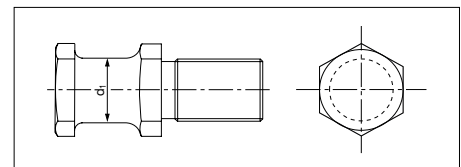

Per sicurezza, il peso dello stampo deve essere sopportato da 2 soli perni. *For safety, consider that the weight of the die has to be supported just by 2 lifting pins.*

VW code	Carico max Max load (Kg)	Peso max stampo Max. die weight (Kg)	d1	VW code	Carico max Max load (Kg)	Peso max stampo Max. die weight (Kg)	d1
39V 1199/1	320	640	16	39V 1199/4	1500	3000	32
39V 1199/2	500	1000	20	39V 1199/5	2500	5000	40
39V 1199/3	1000	2000	25				

Esempio di ordinazione/Order example = 39V 1199/1 (VW code)

Rispettare il carico max. *Respect the max load.*



Centraggio *Locating pins*



Codice/Code	Materiale/Material
Cod. 39V 1205	16MnCr5; HRC 58 ÷ 62

VW code	d1	l1
39V 1205/1	22	45
39V 1205/2	22	55
39V 1205/3	40	55
39V 1205/4	40	65
39V 1205/5	40	85
39V 1205/6	50	55
39V 1205	32	50

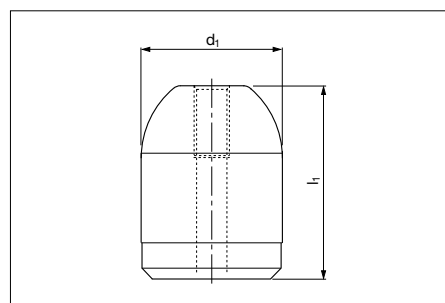

Esempio di ordinazione/Order example = 39V 1205/1 (VW code)

Riferimento *Gage*

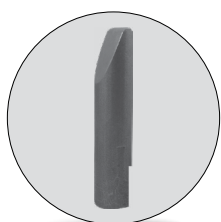

Codice/Code	Materiale/Material
Cod. 39V 1242	16MnCr5; HRC 58 ÷ 62

VW code	d1	l
39V 1242/5	16	???
39V 1242/6	20	???
39V 1242/7	25	???
39V 1242/8	32	???

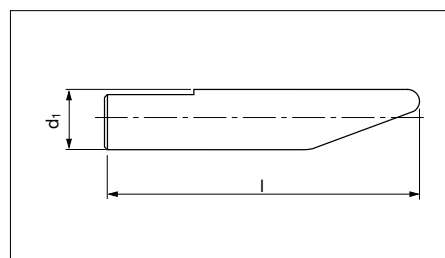

Esempio di ordinazione/Order example = 39V 1242/5+l (VW code+l)

I da indicare in fase di ordinazione.
I Indicate when ordering.

Tassello di centraggio *Locating block*

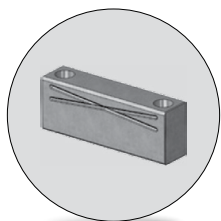

Codice/Code	Materiale/Material
Cod. 39V 1254	16MnCr5; HRC 58 ÷ 62

VW code	l1
39V 1254/10	100
39V 1254/11	125
39V 1254/12	160
39V 1254/13	200

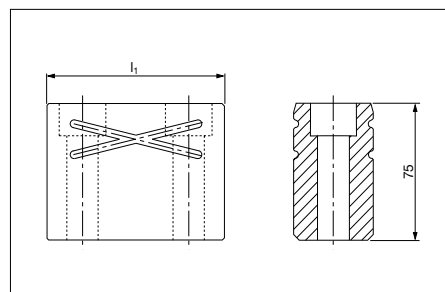

Esempio di ordinazione/Order example = 39V 1254/10 (VW code)

Chiavetta *Key*

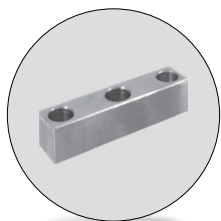

Codice/Code	Materiale/Material
Cod. 39V 1304	CK45

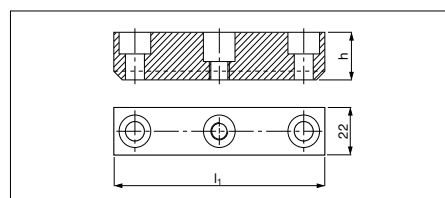

VW code	h	l1	VW code	h	l1	VW code	h	l1
39V 1304/1	14	50	39V 1304/7	22	50	39V 1304/11	40	50
39V 1304/2	14	80	39V 1304/8	22	80	39V 1304/12	40	80
39V 1304/3	14	100	39V 1304/9	22	100	39V 1304/13	40	100
39V 1304/4	14	125	39V 1304/10	22	125	39V 1304/14	40	125

Esempio di ordinazione/Order example = 39V 1304/1 (VW code)

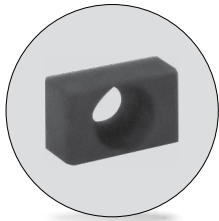

Chiavetta *Key*

Codice/Code	Materiale/Material
Cod. 39V 1304	CK45
VW code	s1
39V 1304/5	12
39V 1304/6	16

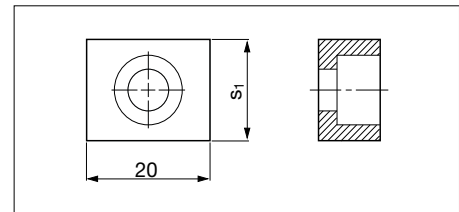

Esempio di ordinazione/Order example = 39V 1304/5 (VW code)

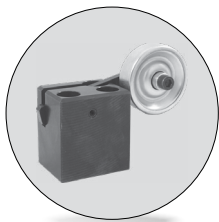

Rullino sollevamento nastro *Roller stock lifter*

Codice/Code	Materiale/Material
Cod. 39V 1569	Acciaio/Steel

VW code	Forma/Form
39V 1569/1	A
39V 1569/2	B

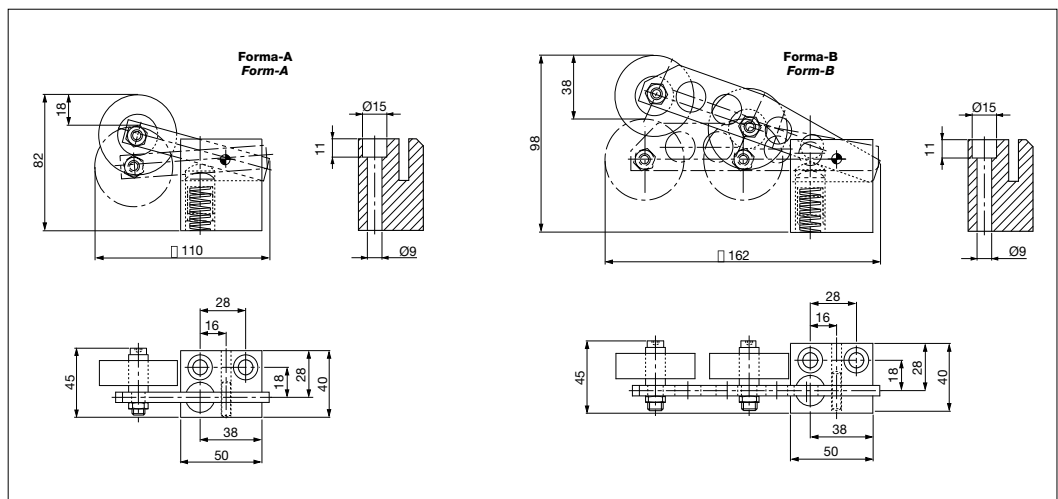

Esempio di ordinazione/Order example = 39V 1569/1 (VW code)

INDEX

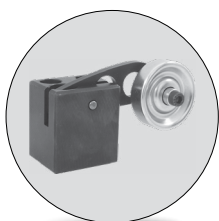

Rullino sollevamento nastro *Roller stock lifter*

Codice/Code	Materiale/Material
Cod. 39V 1569	Acciaio/Steel

VW code	Forma/Form
39V 1569/3	C
39V 1569/4	D

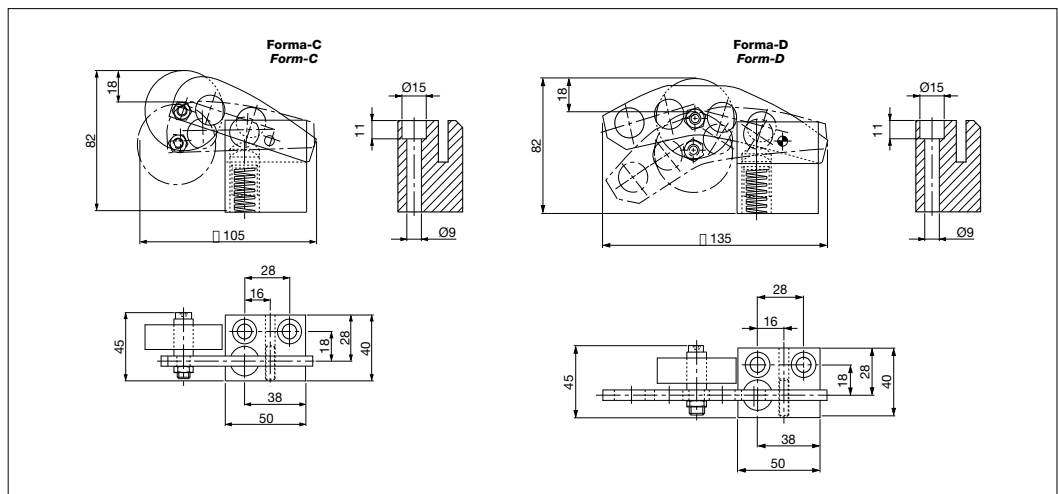

Esempio di ordinazione/Order example = 39V 1569/3 (VW code)

AUTOMOTIVE

Rullino sollevamento nastro *Roller stock lifter*

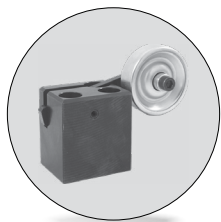

Codice/Code	Materiale/Material
Cod. 39V 1569	Acciaio/Steel

VW code	Forma/Form
39V 1569/10	A
39V 1569/11	B

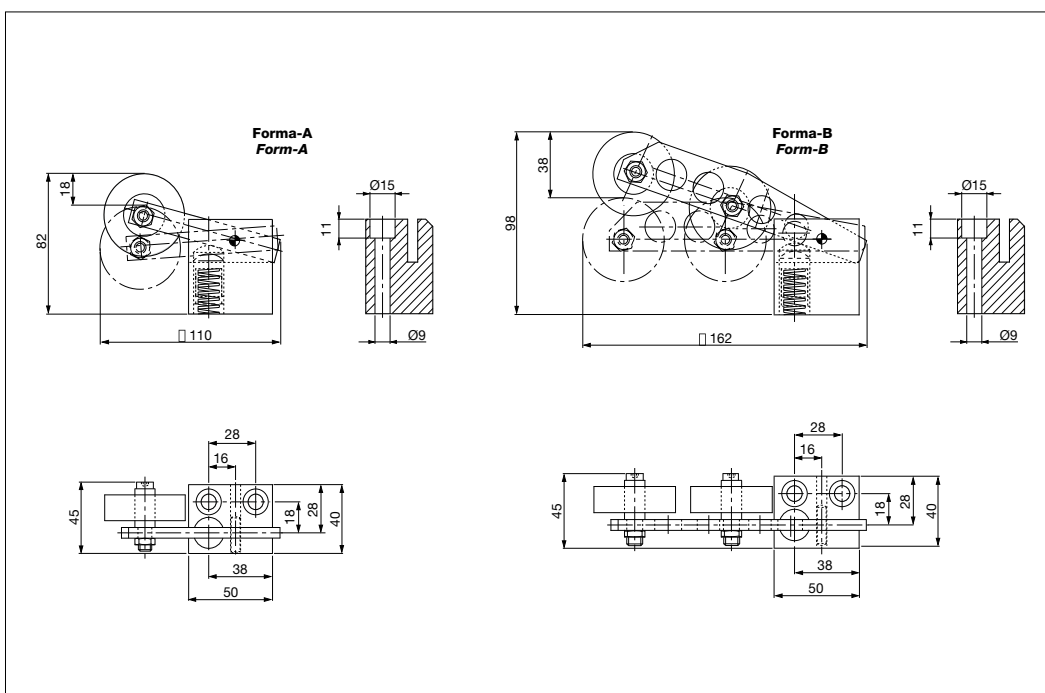

Esempio di ordinazione/Order example = 39V 1569/10 (VW code)

Rullino sollevamento nastro *Roller stock lifter*

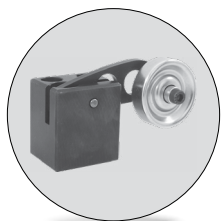

Codice/Code	Materiale/Material
Cod. 39V 1569	Acciaio/Steel

VW code	Forma/Form
39V 1569/12	C
39V 1569/13	D

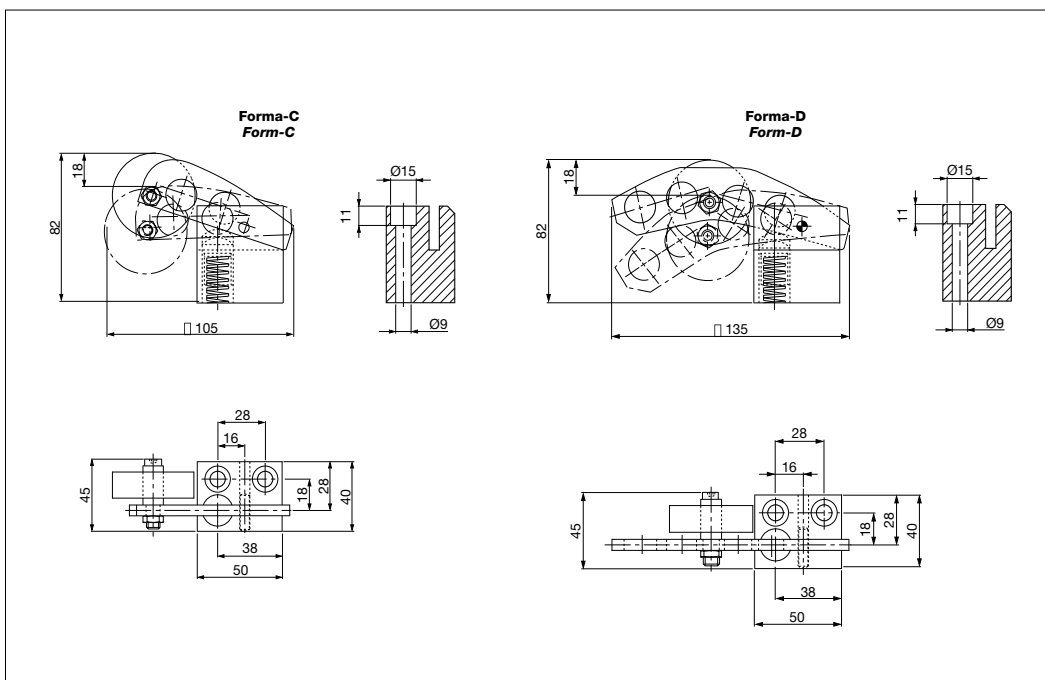

Esempio di ordinazione/Order example = 39V 1569/12 (VW code)